



Maximum utilization rates. Maximum productivity. 100 percent mining

280 SM (i) SURFACE MINER



MAXIMUM UTILIZATION RATES. MAXIMUM PRODUCTIVITY. 100 PERCENT MINING.

High-performance surface miners for reliable, selective extraction of raw materials by direct loading, sidecasting, or cut-to-ground.

Raw materials are extracted and crushed in situ in purest quality in a single operation - without drilling and blasting, and with minimal environmental impact.

The all-rounder for all rock hardnesses and applications with a variety of cutting drums.

The 2,750 mm cutting drum unit with a cutting depth of up to 650 mm is precisely adaptable to each specific application and achieves outstanding cutting performance with minimal pick wear.

The powerful rear loading conveyor with a slidable counterweight can be elevated and slewed to ensure a perfect flow of materials and makes it possible to load trucks with payloads of up to 100 tons.





WIRTGEN SURFACE MINERS

60-TON CLASS

- > Cutting width up to 3,800 mm
- > Cutting depth up to 350 mm

120-TON CLASS

- > Cutting width up to 2,750 mm
- > Cutting depth up to 650 mm

200-TON CLASS

- > Cutting width up to 4,200 mm
- > Cutting depth up to 830 mm

OVERVIEW OF HIGHLIGHTS

Superior technology for efficient mining

01 Maximum Reliability and Utilization Rates

- > 30.5-liter diesel engine with long-life service components
- > FEM-supported chassis design for a calculated service life of 45,000 operating hours
- > Robust, modular CAN bus system, in part with dual-channel signal transmission
- > Balanced load distribution on the track units thanks to the machine's optimized center of gravity

04 Advanced Engine Technology

- > Field-tested high-performance engine cooler with individually exchangeable segments for maximum availability
- > Variable cooler fan control for optimum power utilization and low fuel consumption
- > Powerful diesel engine with high maximum torque compliant with US EPA Tier 2 + US EPA Tier 4f / EU Stage 5 exhaust emission standards
- > Efficient engine control for low fuel consumption and low exhaust gas and noise emissions



02 Highly Efficient Cutting Technology

- > Wear-resistant pick holder systems for optimal pick utilization and minimal downtimes
- > Soft rock cutting drum unit for minimized resistance in the drum housing and optimal material flow
- > Hard rock cutting drum unit for maximum durability in hard rocks
- > Reinforced cutting drum drive stands up to even the toughest mining conditions

03 High Productivity

- > High-performance conveyor unit with slidable counterweight for loading mining trucks
- > High machine availability for maximum mining productivity
- > Fuel tank capacity designed for 24-hour operations
- > Water tank capacity of 3,300 l for long working intervals
- > Six cutting drum speed settings

05 Intelligent Maintenance Concept

- > Direct access to all service and maintenance points
- > Safe and easy assembly and dismantling of the primary conveyor in around six hours when changing belts
- > On-board computer displays service reminders, error messages and diagnostics functions in plain text

06 Effective Safety Concept

- > Lockout-station - mechanical lockout of the electrical system and engine when idle or during maintenance
- > Operator's cabin with operator's seat and built-in, certified ROPS / FOPS set-up as well as trainer's seat for safe, practice-oriented driver training
- > Dust-tight pressurized operator's cabin and fresh air filtration effectively prevent dust ingress
- > Comprehensive machine lighting with LED lights for the working area, discharge conveyor lights, and illuminated access ladders and walkways

07 High Operator-Comfort - Perfect Ergonomics

- > Rotating operator's cabin and a camera/monitor system with six cameras provide a permanently optimal overview of the working area
- > Operating concept based on the latest ergonomic standards for hours of fatigue-free work
- > Operator's cabin mounted on the front left chassis column and decoupled from the machine body

08 Optimal Advance & Fast Turning

- > Large B8 crawler units all-round
- > Four steering modes and separately steerable rear axle
- > Hydraulic all-track steering with Ackermann steering system for optimal maneuverability and minimal wear
- > Automatic leveling parallel to the ground

09 Precise Leveling with LEVEL PRO ACTIVE

- > LEVEL PRO ACTIVE leveling system integrated in the on-board computer
- > Automatic function for the creation of smooth ramps
- > Manual floating position of side plate lifting cylinders

10 Environmentally Sustainable Machine Technology

- > Efficient water management with automatic functions
- > Enclosed material transfer point on the conveyor unit reduces dust emissions
- > Sealed cutting drum housing
- > Automatic central lubrication system with monitored lubricant circuit



MAXIMUM UTILIZATION RATES FOR MAXIMUM PRODUCTIVITY



Efficient Material Mining

In the extraction of primary resources by open cast mining, the key priority is always a combination of highest possible productivity, maximum purity of the material mined, and the reduction of impact on people and the environment to a minimum. Apart from performance, the productivity of mining equipment depends primarily on constant operational readiness and optimum machine utilization.

Only a reliable and maintenance-friendly machine can guarantee high utilization rates. At the same time, the machine operator must be offered an ergonomically designed working environment that minimizes fatigue to ensure that the combination of high operational readiness, maximum machine utilization rates, and high productivity can be realized.

The 280 SM(i) surface miner delivers on all these points and recommends itself as the tool of choice for cost-efficient mining processes in the 120-ton class.

Diesel Engine with Long-Life Service Components

The 280 SM(i) is ideally equipped for the tough conditions encountered in open cast mining operations. The basis for this is a 30-liter diesel engine with long-life service components that's built to last, a ruggedly constructed cutting drum unit, and an extremely efficient discharge conveyor. Set up and combined as

a powerful and efficient unit on a chassis that, thanks to the use of state-of-the-art technologies, could be designed for a service life of 45,000 hours.

Rugged Electrics Concept with CAN Bus Reserve Circuits

If the need arises, the CAN bus can be flexibly reconnected via backup circuits. The most important controls are equipped with two-channel signal transmission to ensure that functions will still be carried out in the event of signal failure on one of the channels. An error message displayed on the operating console notifies the operator when a signal failure occurs.





One Goal - Sustainable Maximum Performance

High operational readiness, maximum machine utilization rates, and high productivity

Maintenance-Friendly Design

Easily accessible servicing and maintenance points, a walk-in engine compartment, and no end of smart detail solutions enable plannable and conveniently realizable maintenance and servicing activities. The color display of the machine's onboard computer shows service reminders and diagnostics functions in plain text, which provide valuable information for preventive maintenance of the machine. This secures highest levels of long-term reliability.

Focused on People - the Ergonomic Operator's Cabin

The operator's cabin with all-round glazing is swivel-mounted on the front chassis column and provides a consistently optimal all-round view of the working area. An operating concept in line with the latest standards of ergonomics provides an ideal work-space that is an inviting aid to high productivity and enables the operator to work for hours with minimal fatigue.



ULTRA-EFFICIENT CUTTING TECHNOLOGY

Wear-Resistant Pick Holder System

During surface mining operations, the cutting drum, and especially the pick holder, are subjected to enormous peak loads. In view of this, all components of the cutting drum are designed to cope with these massive stresses that occur during the cutting process. The HT14 welded pick holder features a particularly strong and robust shank that acts as armor against wear. After in-depth analysis of the customer's needs, our mining experts give professional advice on the choice of the right mining picks for the job.

Soft Rock and Hard Rock Cutting Drum Units

Hard rock cutting drums are used when cutting in particularly hard and abrasive rock. Here, the cutting drum and the drum

housing are additionally armored with special wear elements. A soft rock cutting drum is the more suitable solution when cutting in softer rock. It offers minimized resistance inside the cutting drum housing and optimizes material flow. When precisely adapted to the job at hand, cutting drums achieve high area performance rates with minimal pick wear.

The cutting drum housing is sealed at the sides by two hydraulically lifting side plates. An integrated sprinkler unit reduces the generation of dust.

Mechanical Cutting Drum Drive

The cutting drum is driven by a robust mechanical power belt drive. The outstanding efficiency of this system guarantees high cutting performance.



01 High-productivity cutting drum manufactured from wear-resistant materials.

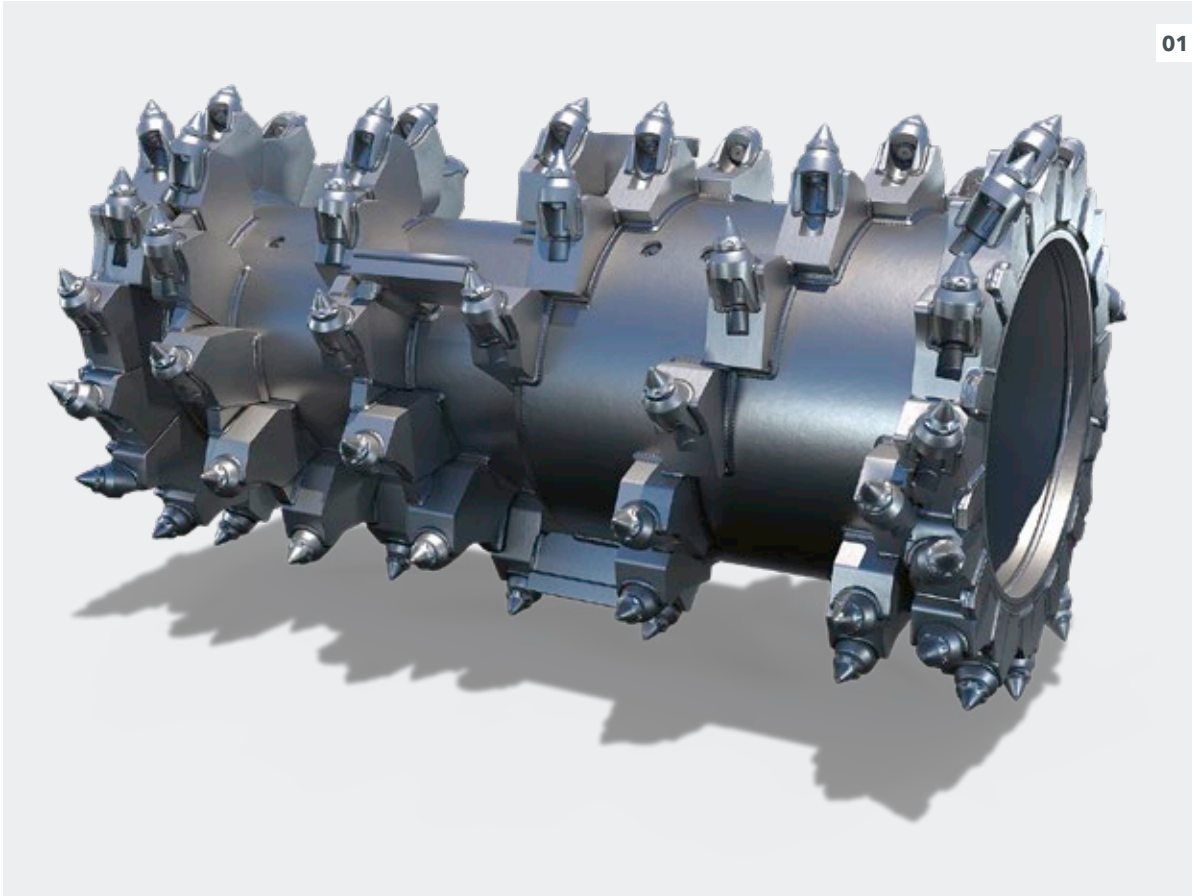

01

Proven in Open Cast Mining

Long-life pick holder

HT14 Pick Holder System

The innovative HT14 toolholder system assures maximum utilization of picks and minimal downtimes.

- 01 Heat-treated holder shank with enormous hardness and high strength as armor against wear
- 02 Rugged shank receiver for WIRTGEN 42 mm round-shank picks
- 03 In the event of high continuous pick use, additional fixing option for cutting tools by means of a securing ring
- 04 Large opening in the top part for optimum access when changing picks
- 05 Welded pick holders stand up to even the highest loading stresses

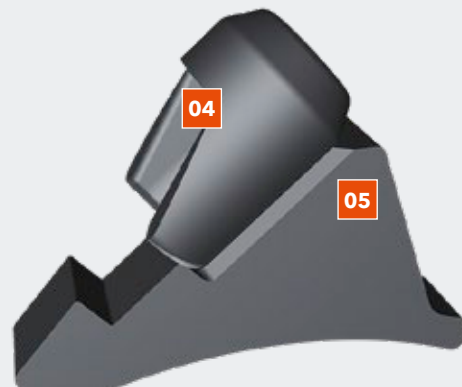
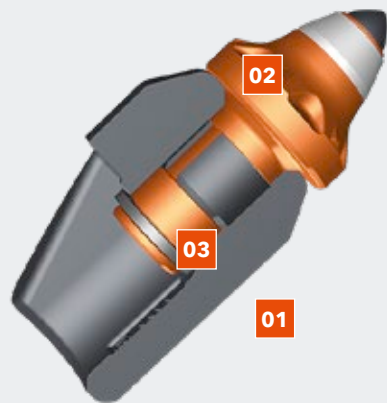

HIGH PRODUCTIVITY

In continuous, 24/7 operation

Unrivalled Utilization Rates

For maximum productivity

Direct Loading, Sidecasting, or Cut-to-Ground

The right concept for every application



- 01 Material depositing by sidecasting.
- 02 Slidable counterweight for optimum position of center of gravity.

02



01



Several Loading Options

The 280 SM(i) is extremely versatile when it comes to offloading the mined materials. The material can be offloaded directly onto trucks or dumpers to the side with the 11.3 m discharge conveyor, sidecast in piles to either side with the slewing discharge conveyor, or deposited in windrows behind the machine. When using the cut-to-ground method, the material can also be deposited directly behind the cutting drum housing. As this method no longer requires a belt conveyor, it frees-up additional power reserves that can be used for the cutting process.

High-Performance Conveyor Unit

The discharge conveyor impresses with high conveying capacity, hydraulically adjustable discharge height, and a slewing angle of 90° to the left and to the right. Thanks to its slidable counterweight, the ideal centre of gravity of the machine can be ideally maintained at all times. The material cut by the surface miner can be deposited at either side of the machine or loaded directly onto transport vehicles. This enables, for example, problem-free loading of mining or

quarrying dumpers with a payload of up to 100 tons. What's more, the operator can continuously vary the speed of the belt independent of the engine speed to minimize belt wear dependent on the material volume and the piece-size of the mined material.

Long Refill Intervals for High Continuous Utilization

To avoid the machine standing idle and to assure maximum utilization rates, the fuel tank of the machine is dimensioned to enable 24-hours of mining at a stretch. In addition to a 2,350-liter diesel fuel tank, the 280 SM(i) also carries an onboard water tank with a capacity of 3,300 liters that also helps to achieve longest possible periods of machine utilization.

Six Cutting Drum Speed Settings

Three different cutting drum speeds can be set from the operator's cabin. In addition, changing the V-belt pulley in the belt drive enables the realization of a further speed range, and makes it possible to select another three speeds from the operator's cabin.

SUSTAINABLE PERFORMANCE AND EFFICIENCY

Power meets efficiency in an engine that's built to last



Rugged and Powerful

Long-life mining engine

01 High-performance engine cooler with individually exchangeable segments.

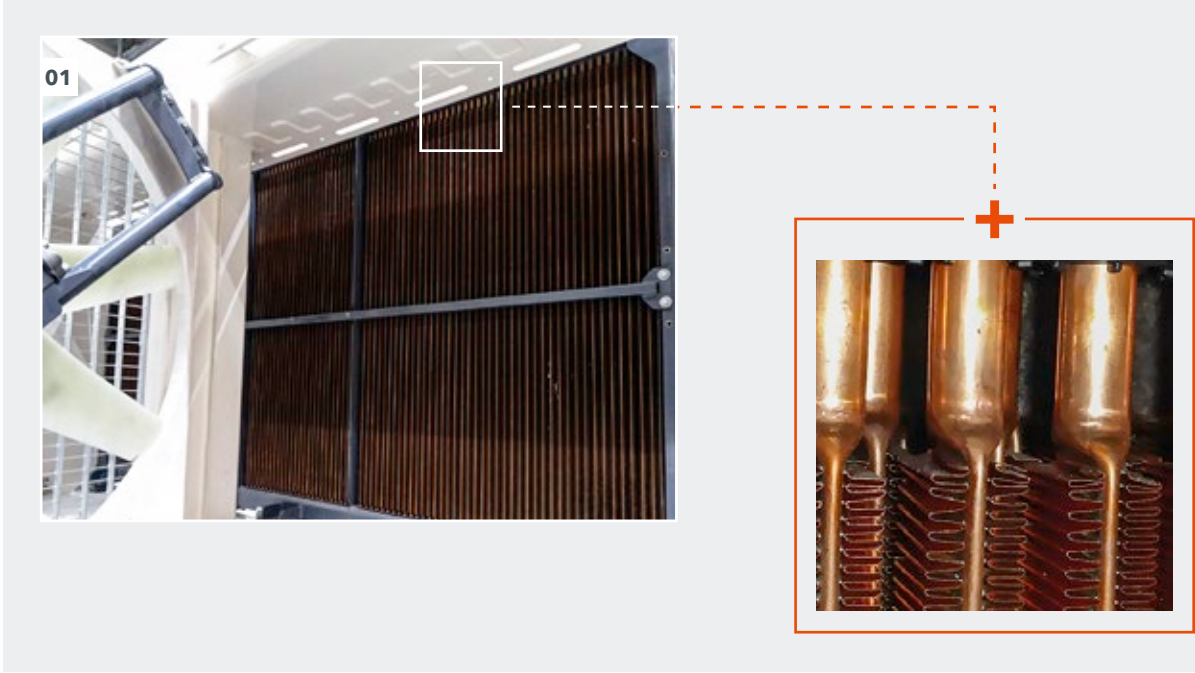

State-of-the-Art Engine with Mining Specs

The 280 SM(i) is equipped with a powerful 30-liter diesel engine that delivers high torque and rated power output. Due to long maintenance intervals and outstanding performance under continuous peak load, the engine is ideal for mining operations. It is rugged and powerful, and has already chalked-up an impressive track record for reliability and endurance on numerous open cast mining sites. The engine also impresses with low operating costs per hour and enables outstanding utilization rates and continuous operation hours. Featuring the latest upgrade of the Cummins QST30 engine, the machine is now at the cutting edge of current technology. The high-pressure common rail fuel system and efficient engine control ensure low fuel consumption and low exhaust gas and noise emissions. The exhaust aftertreatment system also reflects the current state-of-the-art and ensures that the surface miner fulfills all requirements of the stringent US EPA Tier 4f / EU Stage 5 (280 SM i) exhaust emission standards.

High-Performance Engine Cooler

It's clear that a muscular beast like the 280 SM(i) also needs capable and reliable thermal management. The optimization of the engine's heat regime focuses on the reduction of fuel consumption and harmful emissions and additionally guarantees optimal engine and aggregate cooling in all aspects of machine operations. Field-proven in the toughest mining scenarios, the engine cooler guarantees optimal heat dissipation under even the most adverse conditions. It features individually exchangeable cooling segments that can be quickly and easily removed and replaced in the field in the event of damage without the need to remove the complete cooling package. This saves time, increases the utilization rate, and reduces operating costs.

Variable Cooler Fan Control

Variable cooler fan control regulates the fan speed according to the actual cooling demand. This assures optimal power utilization, lowers fuel consumption, and reduces the extraction costs per ton.

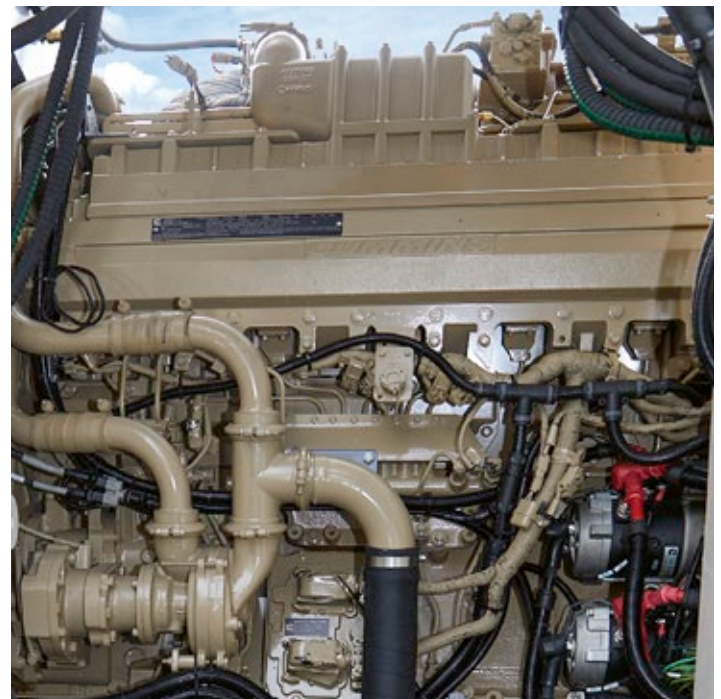

EASY SERVICING AND MAINTENANCE

Minimal Maintenance Effort

Operators of the 280 SM(i) demand machine utilization capability around the clock. And this means that minimizing the time spent on maintenance is an absolute must. A smart maintenance concept is the key to maximizing utilization capability and maintaining consistently high levels of productivity. Regular servicing and maintenance are the best preconditions for highest possible reliability, the prevention of production stoppages, and lengthening the service life of components. The machine's onboard computer helps the machine operator to implement the maintenance schedule. It displays service reminders, error messages, and diagnostics functions in plain text. The automatic central lubrication system guarantees consistently optimal provision of lubricants to the 115 lubrication points and significantly reduces servicing and maintenance effort.

Direct Access

The walk-in engine compartment enables direct access to all service and maintenance points. The machine's air, fuel, and hydraulic oil filters are all easy accessible. Checking fluid levels takes only a few moments. Wearing parts can be quickly and easily removed and replaced.

Minimal Idle Times

Safely changing a pick with the hydraulic pick ejector and the electro-hydraulic cutting drum rotation device takes only a matter of minutes.

Hinge-Mounted Cooler with Easy Maintenance Access

The cooler on the right-hand side of the machine can be unlocked and swung out for maintenance. This enables easy clean-

Time Is Money

Fast servicing

Primary Conveyor Belt Replacement

Assembly and Dismantling of the Primary Conveyor in Around Six Hours when Changing Belts

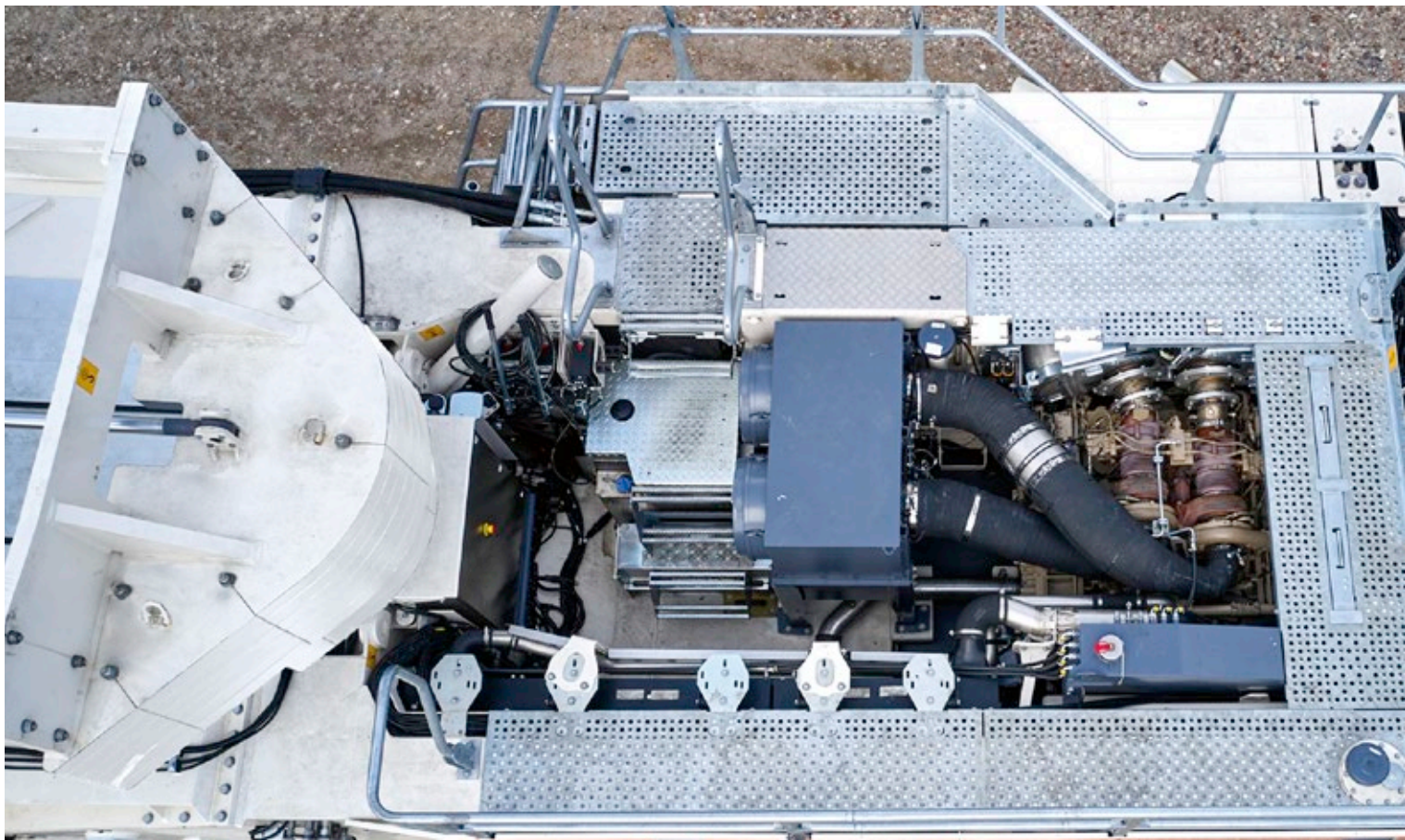

- 01 The hydraulic pick ejector and the remote control for the cutting drum rotation device are easily accessible and always ready for use.
- 02 The electro-hydraulically powered cutting drum rotation device and the hydraulic pick ejector significantly increase the machine's utilization rate.

ing of the fans and provides additional access to the engine from the side for maintenance purposes.

Fast Primary Conveyor Belt Replacement

The assembly and dismantling of the primary conveyor for belt replacement is made easier by a maintenance shaft. The discharge conveyor can remain on the machine during the process, which can be completed within around six hours.



03 All servicing points are easily accessible.

04 Access to the engine and cooler from the side.



UNCOMPROMISING SAFETY

Safety Always Takes Absolute Priority

The safety of operating and maintenance personnel always tops our list of priorities. The surface miner fulfills the exceptionally stringent mining regulations that apply at all open cast mining sites around the globe. For instance, access ladders and walkways must be manufactured with non-slip materials and must be illuminated by bright lights, which also applies to all service points.

The Operator's Cabin Sets Entirely New Standards

On the 280 SM(i), a dust-sealed pressurized cabin and air filtration effectively prevent the ingress of dust into the operator's

workplace. The cabin is fitted with a seat for the operator, an integrated, certified ROPS/FOPS set-up, and an additional seat for a trainer for safe practical training of inexperienced operators on the machine.

Lockout-Station

Inadvertent powering-up of the machine during maintenance can be prevented by the mechanical power-on-disabled switch for the electrical system. When the machine is idle, both the electric starter circuit for the diesel engine and all battery power to the machine can be deactivated to ensure the safety of service or maintenance personnel.

Safety First!

For the operator and everyone in the vicinity of the machine



- 01 If required, the lockout-station deactivates the electric starter circuit for the diesel engine or the entire battery power to the machine.
- 02 Comprehensive machine lighting for the illumination of all relevant working areas.



Comprehensive Machine Lighting

When working at night, safe operation is ensured by bright illumination of all relevant working areas on the surface miner. The high-powered lighting on the 280 SM(i) comprises LED floodlights for the working areas, lamps on the discharge conveyor, and brightly-illuminated access ladders and walkways.

When working at night, eye-fatigue is prevented by lighting with a red tone that provides comfortable working light inside the cabin without the risk of dazzling the operator. The comprehensive lighting system also features a practical “Welcome and Go Home Lighting” that ensures that the operator doesn’t have to begin or end shifts in the dark.

HIGH OPERATOR-COMFORT - PERFECT ERGONOMICS

A Stress-Free Workplace

For maximum productivity

Everything under Control

Ergonomic operating concept

Automated Processes

Automatic functions reduce the operator's workload

01

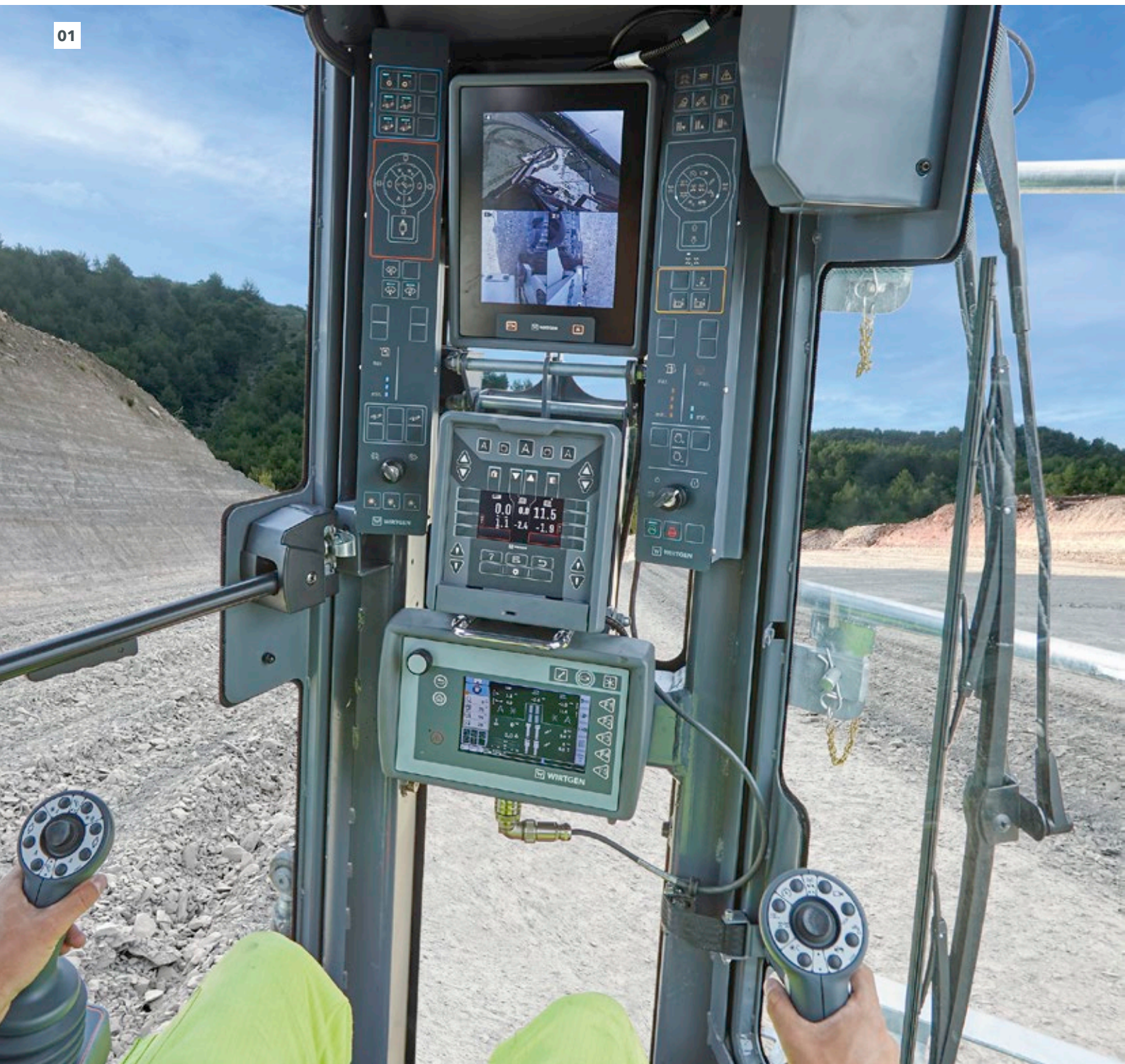

Ergonomically Designed Operator’s Workplace

The operator’s cabin has been completely redesigned and is now characterized by comfort, ergonomically designed control elements, a premium look and feel, and modern design. As ergonomics, comfort, and operator-friendliness are significant factors for assuring profitability, its construction integrates the latest findings from the field of ergonomics. They enhance well-being and, in turn, the performance of the operator and lead to higher productivity.

Rotatable Operator’s Cabin

The operator’s cabin is mounted on the front left chassis column and decoupled from the machine body. It can be rotated by 90° to each side. This means that the machine operator has an ideal overview of the entire process at all times. On one side, the operator can visually monitor the loading process and, on the other, has an excellent overview of the work in progress. All essential displays, the onboard computer, and the control panel of the **LEVEL PRO ACTIVE** leveling system are centrally arrayed in front of the operator. This means that the most important process information is available to the operator at all times. Instead of the operator’s seat being rotated to the side into its working position as is otherwise usual, the entire cabin is rotated and all controls and displays now always remain in the same position for the operator.

High-Quality Camera System with up to 6 Cameras

The W 280 SM(i) can be equipped with up to 6 cameras. This makes it much easier for the operator to keep an eye on what’s going on around and on the machine. The cameras are mounted on the discharge conveyor, on the left-hand and right-hand side plates, and at the rear of the machine. The image data from



these cameras is displayed on a 10.4" high-resolution monitor with high viewing angle stability. The layout of the visual content displayed on the monitor can be freely chosen. The cameras themselves can be tilted and panned and are automatically heated at low ambient temperatures.

Joystick-Control in the Multifunctional Armrests

The 280 SM(i) is controlled with two joysticks integrated in the multifunctional armrests. The controls for all essential machine functions can be found on the multifunctional joysticks. The ergonomically designed control elements are integrated into the armrest of the operator’s seat.



01 Ergonomics and comfort increase the operator’s well-being and performance.

02 Multifunctional joystick in the armrest.

03 The cabin can be rotated by 90° to each side.

OPTIMAL ADVANCE AND FAST TURNING IN TIGHT SPACES

Rugged Crawler Units for Outstanding Traction and Maneuverability

Drawing on past experience, unexpected challenges are almost inevitable on the terrain of open cast mines, where optimal traction, maneuverability, and ground clearance are often the order of the day – all of which are key features in the repertoire of the 280 SM(i). It runs on B8 crawler units with particularly rugged, heavy-duty double-bar track pads. They have an established reputation for reliability and endurance in the mining segment and deliver optimal ground contact under even the most difficult surface conditions. ISC (Intelligent Speed Con-

trol) is an active track chain control system adapted specifically to cater for the needs of the open cast mining industry that ensures continuous and uniform traction. An electronic traction control system provides controlled reduction of the slipping of individual crawler units. At the same time, ISC adapts the speed of inner and outer crawler units when negotiating curves. This enormously increases the maneuverability of the machine and reduces wear. Continuous speed adjustment is possible across the entire spectrum for both transport mode and working mode.



Uncompromising Advance
Heavy-duty crawler units

Very Good Maneuverability
Ackermann steering and Intelligent Speed Control (ISC)

01 A turning radius of under 9 meters and the good maneuverability enable rapid turning maneuvers.



Four Steering Modes and Separately Steerable Rear Axle

Four selectable steering modes for the hydraulic all-track steering lend the surface miner impressive maneuverability. The rear axle can be steered separately at any time at the press of a button. For positioning, the front and rear crawler units are steered in opposite directions, while, on long, straight cuts, only the front unit is used for steering. In crab steering mode - for lateral repositioning of the machine - all four crawler units are steered in the same direction.

Hydraulic All-Track Steering with Ackermann Steering Principle

Hydraulic all-track steering with the Ackermann steering principle enables tight turning radii and low-wear turning maneuvers. In combination with the ISC active track chain control this guarantees optimal maneuverability in tight spaces. This means that the 280 SM(i) can be rapidly maneuvered and that the productive cutting process is interrupted for as short a period as absolutely necessary.

Automatic Leveling Parallel to the Ground

Automatic leveling parallel to the ground assists the operator especially when lowering and raising the machine into and out of the cut. Machine height adjustment is uniformly applied at the front and rear of the machine to ensure that the adjustment is always parallel to the initial position. This automatic function can be deactivated at the press of a button. When relocating or repositioning the machine, the operator can activate automatic cross-slope control for transport movements. At the press of a button, this ensures that the cross-slope of the machine remains constant when relocating and thus simultaneously reduces the machine operator's workload.

LEVEL PRO **ACTIVE**

Precise leveling - integrated in the machine's control system

LEVEL PRO ACTIVE - The Intuitive and Reliable Leveling System

The new leveling system, **LEVEL PRO ACTIVE**, is integrated in the onboard computer of the 280 SM(i). The value of the system has been confirmed in the field on projects in both the road construction and mining segments. The functionalities of the system have been expanded with ergonomically designed control panels that make operating an intuitive and simple process. The current leveling attitude of the machine is precisely determined by components such as position measuring systems in the side plate lifting cylinders and a cross-slope sensor.

Incomparably level surfaces and conveying routes can then be generated with the aid of these data. Full integration in the machine control system also enables a high degree of automation, as essential machine functions are directly connected to one another.

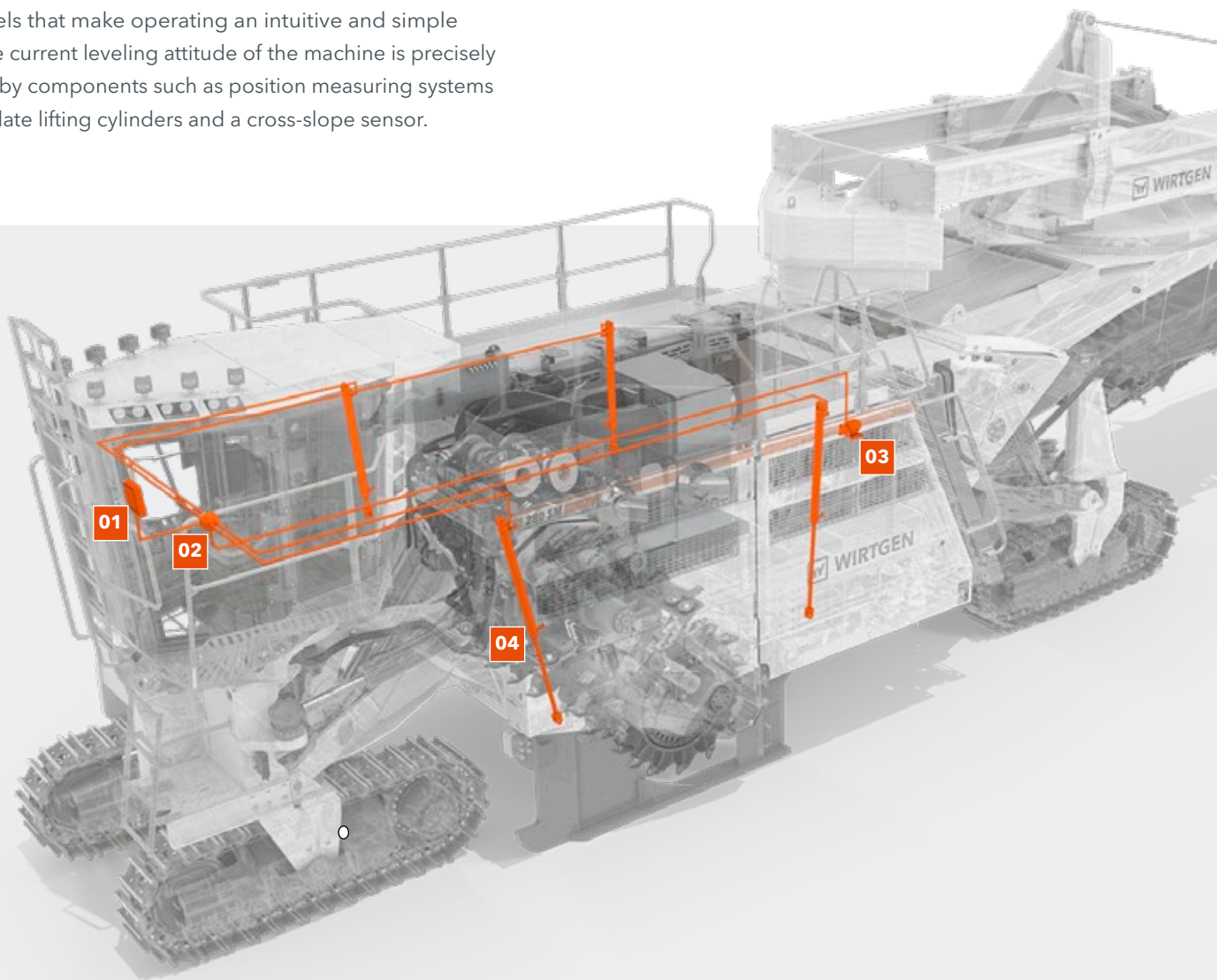

Active Adjustment

The **LEVEL PRO ACTIVE** leveling system

Unparalleled Precision

Integrated displacement sensors

Numerous Additional and Automated Functions

The **LEVEL PRO ACTIVE** leveling system offers many automated and additional functions that make the operator’s job easier. This leads to faster and more precise workflows. For instance, the automatic function for the construction of smooth ramps can be accessed at the press of a button. Automatic leveling parallel to the ground allows the determination of the ideal centre of gravity and can be used to optimize off-road performance.

Manual Floating Positioning of the Side Plate Lifting Cylinders

The side plate lifting cylinders can be independently pressurized. This means that the side plates can be actively tilted and, in loose ground, float on top of the extracted material. This effectively prevents side plates sinking in to soft or loose ground.

Fast and Precise Height Adjustment

The powerful lifting cylinder enables extremely agile height adjustment, which in turn increases the leveling precision of the machine.

3D Leveling

The 280 SM(i) can be fitted with an interface compatible with commonly used 3D leveling systems. When interfaced with the machine, the 3D-System interacts directly with the machine control system and controls the leveling process. This enables the creation of defined planes and surfaces previously constructed in a 3D terrain model

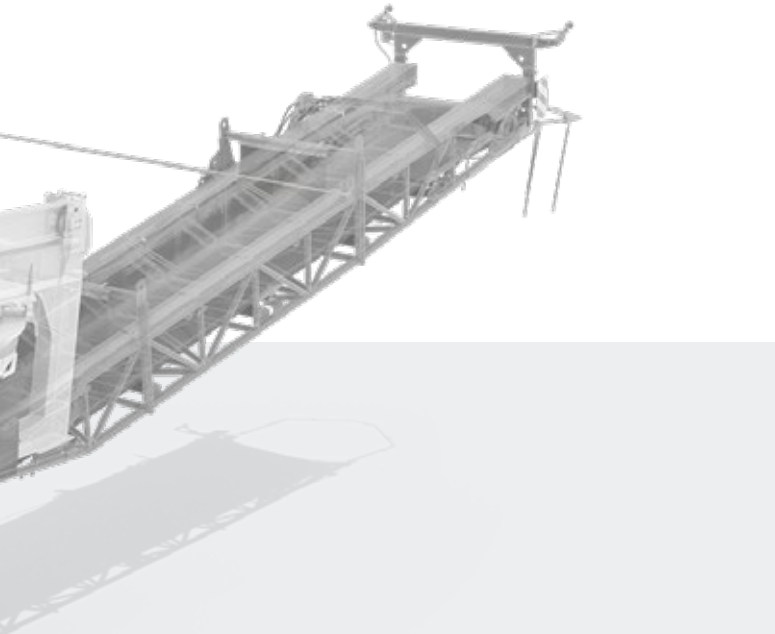

280 SM(i) - Leveling Sensors

- 01** On-board computer and 5" control panel for **LEVEL PRO ACTIVE**
- 02** Machine control system
- 03** Cross-slope sensor
- 04** Side plate hydraulic cylinder with integrated displacement sensor



BUILT FOR THE FUTURE

Sustainable material extraction without drilling or blasting

Environmentally Friendly

Material extraction without drilling or blasting

Resource-Friendly

Efficient extraction of primary resources



Ecologically Sustainable Process with Maximum Productivity

Today, minimizing exhaust fumes, noise, and dust on while maintaining maximum performance and productivity is more important than ever before. In addition to systems for exhaust gas treatment compliant with local emission guidelines, WIRT-GEN offers innovative technologies for the minimization of environmental impacts and for the conservation of natural resources during material extraction without productivity shortfalls.

Mining in a Single Pass

Surface miners extract raw materials in a single pass by means of a mechanical cutting process - without the need for drilling or blasting. The machine cuts, crushes, and loads the mined material in a cost-efficient and environmentally friendly process. In view of this selective extraction process the quality and purity of the mined material is exceptionally high.



Low Specific Fuel Consumption

Advanced engine management, load-dependent engine speed control, a choice of six cutting speeds, and variable cooler fan control ensure minimal fuel consumption and low CO₂ emissions while maintaining maximum extraction performance.



Minimal Water Consumption

Efficient water management with automatic functions for economical water consumption and longer continuous working intervals.



Reduced Dust Emissions

The enclosed material transfer point on the conveyor unit, the sealed cutting drum housing, and the water spraying system effectively reduce dust emissions from the machine.



Reliable Lubrication for Maximum System Functionality

The automatic central lubrication system reliably supplies lubricants to 115 lubrication points. The entire lubricant cycle is constantly monitored to detect damage or leakage in good time.



Low Pick Consumption

Application-specific configuration of cutting drum units and wear-resistant pick holder systems enables optimum pick utilization.





High-performance surface miners for reliable, selective extraction of raw materials by direct loading, sidecasting, or cut-to-ground. Raw materials are extracted and crushed in situ in purest quality in a single operation - without drilling and blasting, and with minimal environmental impact. The powerful rear loading conveyor with a movable counterweight can be elevated and slewed to ensure a perfect flow of materials and makes it possible to load trucks with payloads of up to 100 tons.



TECHNICAL SPECIFICATIONS	280 SM	280 SM i
Cutting drum		
Max. cutting width	2,750 mm	
Cutting depth ¹⁾	0 to 650 mm	
Cutting diameter	1,500 mm	
Engine		
Manufacturer	CUMMINS	
Type	QST 30	
Cooling	Water	
Number of cylinders	12	
Rated power at 2,100 rpm	783 kW / 1,050 hp / 1,065 PS	
Displacement	30.5 l	
Fuel consumption, full load	206 l/h	191.5 l/h
Sound power level in accordance with DIN EN 500-2 Engine operator's platform	≤ 120 dB(A) ≥ 78 dB(A)	
Exhaust emission standards	EU not rated / US EPA Tier 2	EU Stage 5 / US EPA Tier 4f
Electrical System		
Power supply	24 V	
Tank Capacities		
Fuel	2,350 l	
AdBlue® / DEF ²⁾	—	300 l
Hydraulic oil	600 l	
Water	3,300 l	

TECHNICAL SPECIFICATIONS	280 SM	280 SM i
Driving Performance		
Operating speed	0 to 44 m/min (0 to 2.6 km/h)	
Gradeability ³⁾	20%	
Max. transverse tilt	8%	
Crawler Units		
Type	B8	
Crawler units front / back (L x W x H)	3,000 x 510 x 1,050 mm	
Loading System		
Belt width of primary conveyor	1,400 mm	
Length of primary conveyor	6,440 mm	
Belt width of discharge conveyor	1,400 mm	
Length of discharge conveyor	12,000 mm	
Shipping Dimensions		
Transport by sea, variant 1		
> 1 st package: module 1 (chassis, crawler units, engine unit, primary conveyor, operator's cabin, additional weights) (L x W x H)	13,320 x 3,720 x 3,400 mm	
> 2 nd package: module 2 (turntable, conveyor suspension system, counterweight, transport rack) (L x W x H)	6,370 x 3,000 x 2,730 mm	
> 3 rd package: module 3 (discharge conveyor) (L x W x H)	11,940 x 2,200 x 1,530 mm	
> 4 th package: module 4 (cutting drum unit) (L x W x H)	2,400 x 3,850 x 1,800 mm	
Transport by sea, variant 2		
> 1 st package: module 1 (chassis, crawler units, engine unit, operator's cabin) (L x W x H)	13,320 x 3,720 x 3,400 mm	
> 2 nd package: module 2 (turntable, conveyor suspension system, counterweight, transport rack) (L x W x H)	6,370 x 3,000 x 2,730 mm	
> 3 rd package: module 3 (discharge conveyor) (L x W x H)	11,940 x 2,200 x 1,530 mm	
> 4 th package: module 4 (primary conveyor) (L x W x H)	6,000 x 2,200 x 1,000 mm	
> 5 th package: module 5 (cutting drum unit) (L x W x H)	2,400 x 3,850 x 1,800 mm	
> 6 th package: module 6 (additional weights) (L x W x H)	2,440 x 140 x 1,170 mm / 1,280 x 350 x 500 mm	

¹⁾ = The maximum cutting depth may deviate from the value indicated due to tolerances and wear

²⁾ = AdBlue® is a registered trademark of the German Association of the Automotive Industry (VDA)

³⁾ = The gradeability of the machine depends on the ground conditions of the working environment

⁴⁾ = Machine weight, half weight of all consumables, vehicle tool kits, machine operator, excluding optional equipment

TECHNICAL SPECIFICATIONS	280 SM	280 SM i
Weight of Basic Machine		
Empty weight of machine without fluids	113,320 kg	113,920 kg
Operating weight, CE ⁴⁾	116,110 kg	116,875 kg
Maximum operating weight (full tanks, full range of equipment)	118,200 kg	119,830 kg
Transport Weight of Individual Components		
Transport by sea, variant 1		
> Weight of 1 st package: module 1 (chassis, crawler units, engine unit, primary conveyor, operator's cabin, additional weights)	75,400 kg	76,000 kg
> Weight of 2 nd package: module 2 (turntable, conveyor suspension system, counterweight, transport rack)		16,200 kg
> Weight of 3 rd package: module 3 (discharge conveyor)		4,900 kg
> Weight of 4 th package: module 4 (cutting drum unit)		18,000 kg
> Box with add-on components		5,000 kg
Transport by sea, variant 2		
> Weight of 1 st package: module 1 (chassis, crawler units, engine unit, operator's cabin)	67,900 kg	68,500 kg
> Weight of 2 nd package: module 2 (turntable, conveyor suspension system, counterweight, transport rack)		16,200 kg
> Weight of 3 rd package: module 3 (discharge conveyor)		4,900 kg
> Weight of 4 th package: module 4 (primary conveyor)		4,200 kg
> Weight of 5 th package: module 5 (cutting drum unit)		18,000 kg
> Weight of 6 th package: module 6 (additional weights)		3,300 kg
> Box with add-on components		5,000 kg
Weight of consumables		
Water		3,300 kg
Fuel (0.83 kg/l)		1,950 kg
AdBlue® / DEF ²⁾ (1.1 kg/l)	—	330 kg
Additional weight		
Operator and tools		
> Machine operator		75 kg
> Tools		30 kg

¹⁾ = The maximum cutting depth may deviate from the value indicated due to tolerances and wear

²⁾ = AdBlue® is a registered trademark of the German Association of the Automotive Industry (VDA).

³⁾ = The gradeability of the machine depends on the ground conditions of the working environment

⁴⁾ = Machine weight, half weight of all consumables, vehicle tool kits, machine operator, excluding optional equipment

SIDE VIEW / TOP VIEW 280 SM(i)

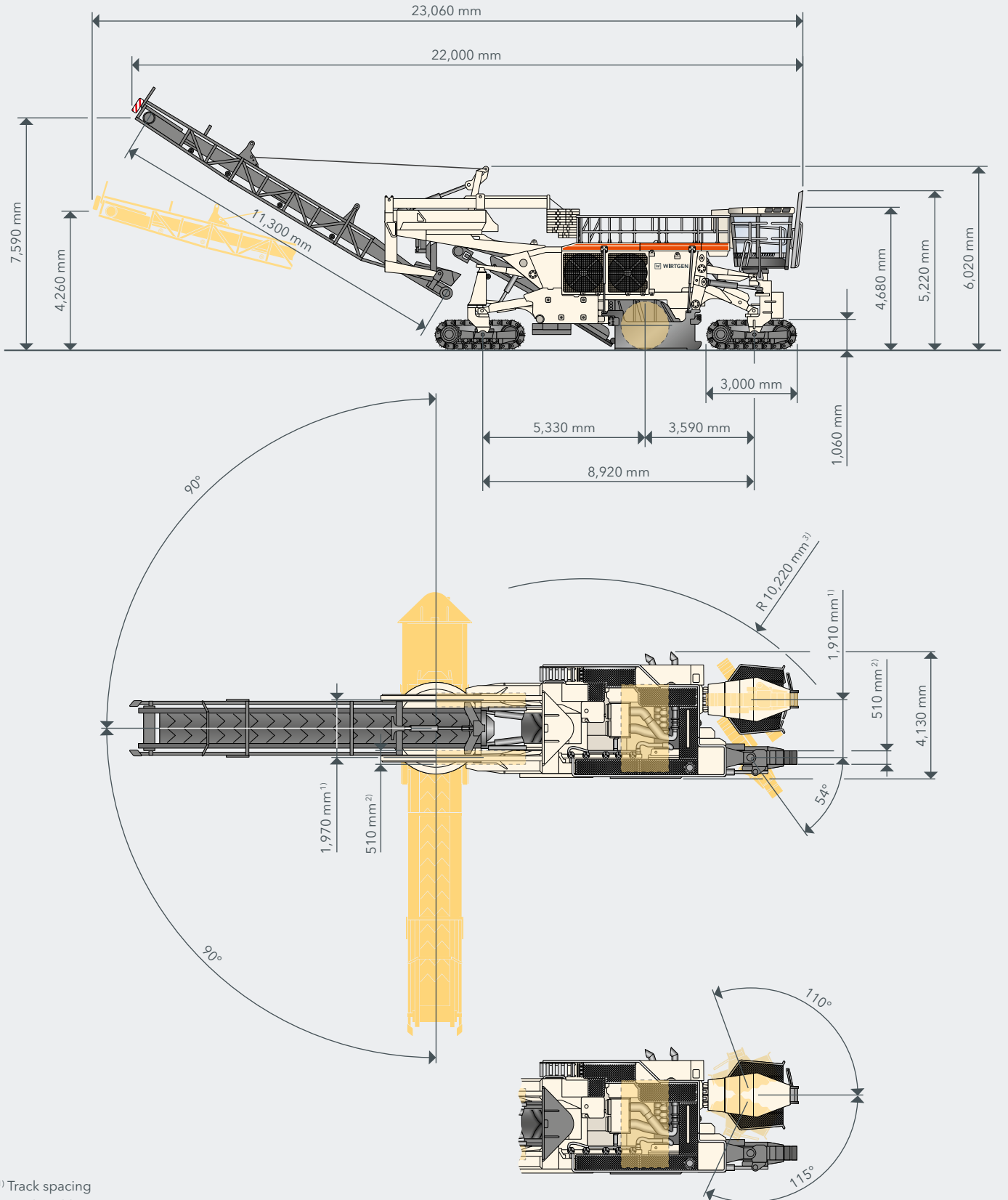

¹⁾ Track spacing
²⁾ Track width
³⁾ Outer turning radius

280 SM(i) TRANSPORT MODULES

Transport Modules for the Transportation of the 280 SM Surface Miner by Sea, Variant 1

1st package: Modul 1 (chassis, crawler units, engine unit, primary conveyor, operator's cabin, additional weights), width 3,720 mm

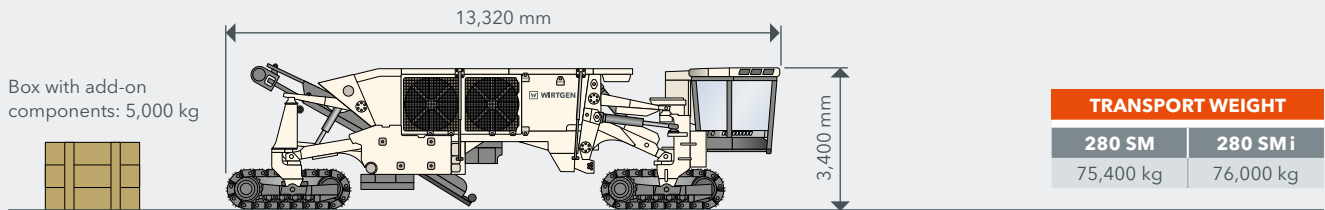

2nd package: Modul 2 (turntable, conveyor suspension system, counterweight, transport rack), width 3,000 mm

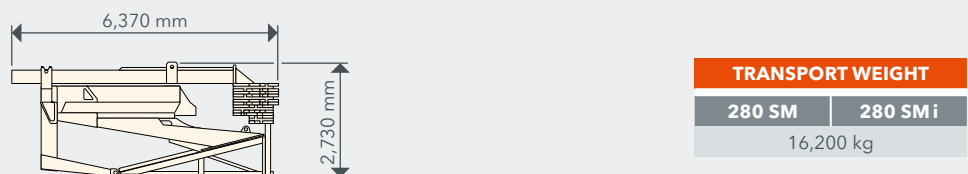

3rd package: Modul 3 (discharge conveyor), width 2,200 mm

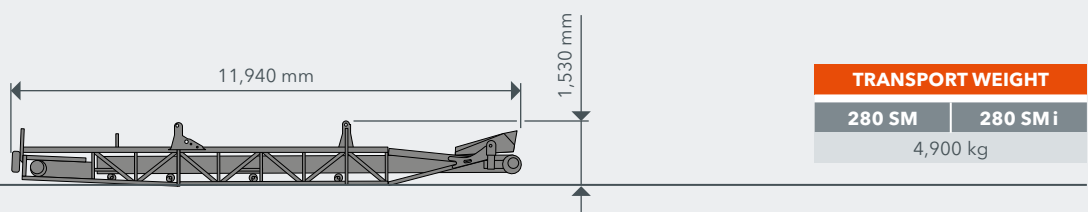

4th package: Modul 4 (cutting drum unit), width 3,850 mm

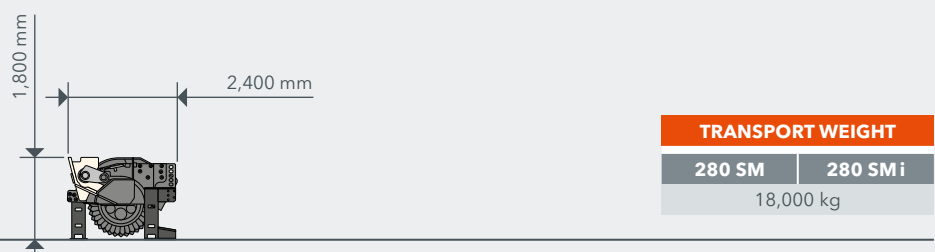

280 SM(i) TRANSPORT MODULES

Transport Modules for the Transportation of the 280 SM Surface Miner by Sea, Variant 2

1st package: Modul 1 (chassis, crawler units, engine unit, operator's cabin), width 3,720 mm

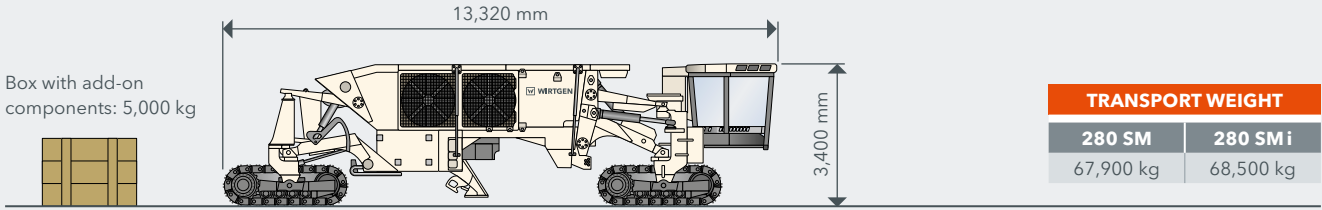

2nd package: Modul 2 (turntable, conveyor suspension system, counterweight, transport rack), width 3,000 mm

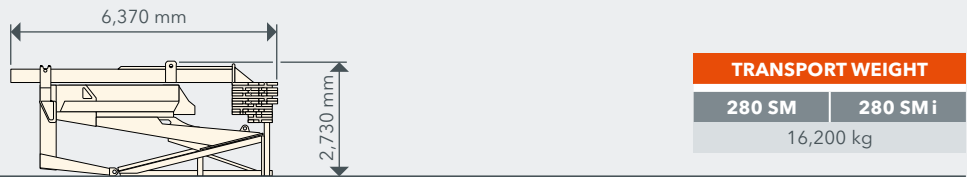

3rd package: Modul 3 (discharge conveyor), width 2,200 mm

TRANSPORT WEIGHT	
280 SM	280 SM i
4,900 kg	

4th package: Modul 4 (primary conveyor), width 2,200 mm

TRANSPORT WEIGHT	
280 SM	280 SM i
4,200 kg	

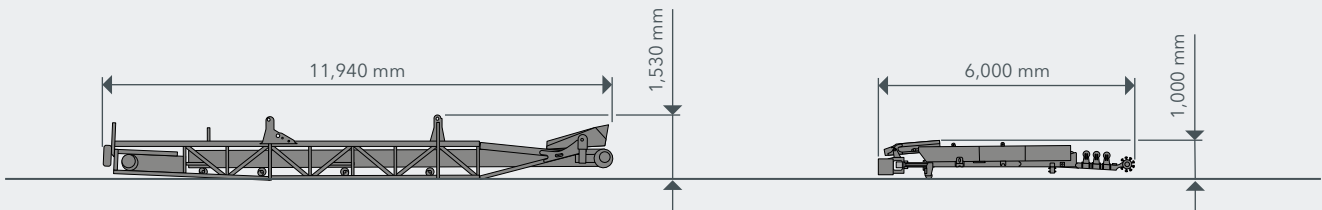

5th package: Modul 5 (cutting drum unit), width 3,850 mm

TRANSPORT WEIGHT	
280 SM	280 SM i
18,000 kg	

6th package: Modul 6 (additional weights), width 140 mm

TRANSPORT WEIGHT	
280 SM	280 SM i
3,300 kg	

width 350 mm

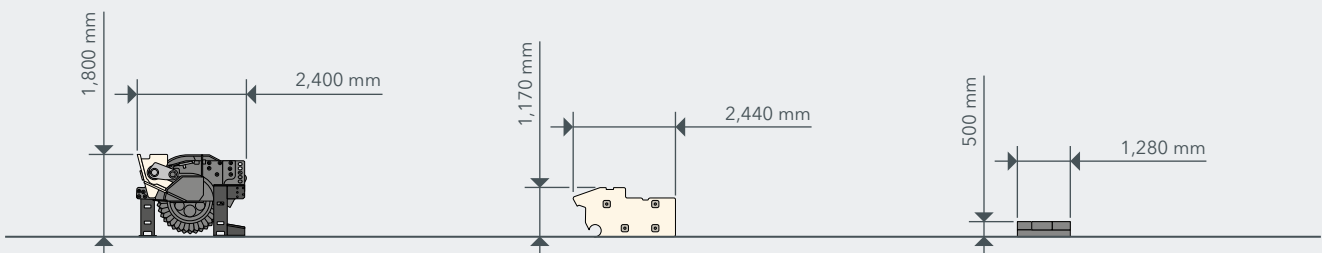

STANDARD EQUIPMENT	280 SM	280 SM i
Basic Machine		
> Base machine with engine	■	■
> Reduced diesel consumption and low noise emissions as a result of temperature-controlled fan speed	■	■
> Lockout station - mechanical lockout of diesel engine or of the electrical system during machine stoppages / maintenance	■	■
> Consumables for using the machine in warm weather conditions (up to -20 °C / -4 °F)	□	□
> High-performance radiator	□	□
Cutting Drum Unit		
> Cutting drum housing for hard rock with reinforced drive	□	□
Cutting Drums		
> Robust and efficient mechanical cutting drum drive via power belts with an automatic belt tensioner	■	■
> Cutting drum speed can be adjusted into 6 steps for optimum working results. 3 selectable engine speeds and adjustable belt pulley arrangements	■	■
> Electrohydraulically driven cutting drum rotation device for quick and safe pick replacement; an electrohydraulic unit permits operation with the diesel engine switched off	■	■
> Cutting drum FB2750 HT14 LA50 with 76 picks - hard rock	□	□
Loading of the Mining Material		
> Powerful, liftable and pivoting rear loading conveyor with a movable counterweight designed to load heavy-duty trucks with capacities of up to 100 t	■	■
> Conveyor unit 280 SM(i)	□	□
> Conveyor suspension with chute for truck loading	□	□
Machine Control and Leveling System		
> Advance control across the entire speed range via an ergonomic joystick with proportional control characteristics	■	■
> Automatic feed control designed to assist the operator maintains the engine's ideal operating point	■	■
> Maximum possible traction force on the track units thanks to hydraulic flow dividers (differential lock on all track units)	■	■
> Cutting depth regulation with an integrated leveling system with side plates and LEVEL PRO ACTIVE , integrated into the machine display	■	■
> The standard transverse slope control maintains the machine's transverse tilt regardless of the terrain. This enables exact surface levels, either horizontal or slanted, to be created	■	■
Operator's Cabin		
> Comfortable, all-round glazed, air-conditioned and soundproofed cabin, mounted on the front left chassis column and rotatable	■	■
> Cabin, on flexible mountings, with heater	■	■
> Air-conditioning system with cooling and heating functions	■	■
> Equipped with an air-cushioned seat and all the necessary control instruments integrated into the armrests	■	■
> Trainer seat to ensure safe, hands-on driver training	■	■
> Illuminated access ladder and walkway to the operator's cabin	■	■
> Reversing camera with graphical reversing assistant	■	■
> Includes 12 V and 24 V sockets and a 5 V USB port	■	■
> "Welcome-and-Go-Home light" function with LED lighting in the ladder area	■	■

STANDARD EQUIPMENT	280 SM	280 SM i
Chassis and Height Adjustment		
> Track units with exceptionally sturdy double-grouser track pads in heavy-duty design for mining applications	■	■
> Infinitely variable, hydraulic four-track drive	■	■
> All-track steering - The steering types "crab", "cornering" or "straight ahead" are possible. In addition, the front and rear track units can be steered separately	■	■
> Machine height is adjusted via swing arms, with two hydraulic cylinders on each swing arm	■	■
> Version with four B8 track units (4 rollers) with double grouser steel track pads	■	■
Miscellaneous		
> Water spray bar on the cutting drum assembly and on the material transfer points	■	■
> High-pressure water cleaner (40 bar, max. 135 l/min) with a washing lance to clean the machine	■	■
> Comprehensive LED lighting system, 24 V	■	■
> Rotary beacon LED 24 V	■	■
> Extensive safety package including easily accessible emergency stop switches, an integrated machine safety feature, protecting it from unintended transverse tilts, large non-slip walkways, a lockable main switch and starting switch and position lights	■	■
> European type certification, EuroTest mark and CE conformity	■	■
> Central lubrication system	■	■
> Standard painting in RAL 9001 (cream)	□	□
> WITOS - professional telematics solution for machine operation and service optimization	□	□

■ = Standard equipment

□ = Standard equipment, can be replaced with optional equipment if desired

□ = Optional equipment

OPTIONAL EQUIPMENT	280 SM	280 SM i
Basic Machine		
> Consumables for use in cold weather conditions (from -20 °C / -4 °F)	<input type="checkbox"/>	<input type="checkbox"/>
> Standard radiator	<input type="checkbox"/>	<input type="checkbox"/>
Cutting Drum Unit		
> Cutting drum housing for soft rock with coaxial drive	<input type="checkbox"/>	<input type="checkbox"/>
> Drum housing shipped separately	<input type="checkbox"/>	<input type="checkbox"/>
> Heavy-duty rollers to help with the assembly of the drum housing	<input type="checkbox"/>	<input type="checkbox"/>
Cutting Drums		
> Cutting drum FB2750 HT14 LA50 with 76 picks - soft rock	<input type="checkbox"/>	<input type="checkbox"/>
> Hydraulic pick ejector for HT14 toolholder system	<input type="checkbox"/>	<input type="checkbox"/>
Loading of the Mining Material		
> Machine equipment for depositing material in the "cut-to-ground" method	<input type="checkbox"/>	<input type="checkbox"/>
> Conveyor suspension with chute für sidecast	<input type="checkbox"/>	<input type="checkbox"/>
Machine Control and Leveling System		
> Level control 3D leveling pre-equipment	<input type="checkbox"/>	<input type="checkbox"/>
> Additional control panel LEVEL PRO ACTIVE	<input type="checkbox"/>	<input type="checkbox"/>
Operator's Cabin		
> Radio system with two speakers and antenna	<input type="checkbox"/>	<input type="checkbox"/>
> Auxiliary heating for cabin	<input type="checkbox"/>	<input type="checkbox"/>
Operator's Cabin		
> Painting in one special color (RAL)	<input type="checkbox"/>	<input type="checkbox"/>
> Model without WITOS	<input type="checkbox"/>	<input type="checkbox"/>
> Electrical preheating (400 V) as a cold start aid	<input type="checkbox"/>	<input type="checkbox"/>
> Wiggins fast-fill system for diesel refuelling	<input type="checkbox"/>	<input type="checkbox"/>
> Wiggins fast-fill system for AdBlue® refilling	—	<input type="checkbox"/>
> Camera system consisting of 4 cameras and 1 screen, series system expandable up to 6 cameras	<input type="checkbox"/>	<input type="checkbox"/>
> System used to detect material by means of a visual separation layer indicator	<input type="checkbox"/>	<input type="checkbox"/>
> High-performance lighting system including 8 LED working lights, 24 V	<input type="checkbox"/>	<input type="checkbox"/>
> Dismantling the machine for transporting	<input type="checkbox"/>	<input type="checkbox"/>
> Workshop container 20' including workshop equipment	<input type="checkbox"/>	<input type="checkbox"/>
> Workshop equipment - tools	<input type="checkbox"/>	<input type="checkbox"/>
> Workshop equipment - auxiliary equipment and consumables	<input type="checkbox"/>	<input type="checkbox"/>
> Workshop equipment - metric fastening elements	<input type="checkbox"/>	<input type="checkbox"/>
> Workshop equipment - electrical repairs	<input type="checkbox"/>	<input type="checkbox"/>
> Workshop equipment - hydraulic components	<input type="checkbox"/>	<input type="checkbox"/>
> Workshop equipment - hydraulic press	<input type="checkbox"/>	<input type="checkbox"/>
> Workshop equipment - hoses for emergency repairs	<input type="checkbox"/>	<input type="checkbox"/>
> Workshop equipment - first service after 50 h	<input type="checkbox"/>	<input type="checkbox"/>

■ = Standard equipment

■ = Standard equipment, can be replaced with optional equipment if desired

□ = Optional equipment



**WIRTGEN GmbH**

Reinhard-Wirtgen-Str. 2
53578 Windhagen
Germany

T: +49-2645-131-0
F: +49-2645-131-392
E: info@wirtgen.com

 www.wirtgen.de



For further information, please scan the code.