



Extraction of primary resources in small and medium-scale mining operations

SURFACE MINER 220 SM(i)



US RELEASE

EXTRACTION OF PRIMARY RESOURCES IN SMALL AND MEDIUM-SCALE MINING OPERATIONS

The 220 SM (i) is the prime choice not only for use in small and medium-scale mining operations but also for routing work and infrastructure projects.

The compact, multipurpose surface miner extracts primary resources with an unconfined compressive strength of up to 50 mpa selectively and at a cutting depth of up to 14 in (350 mm).

The 7 ft 3 in (2.2-m) wide cutting drum unit is tailored precisely to the specific application and guarantees high productivity at low operating costs.

Primary resources are extracted in a single, environmentally sustainable operation without drilling and blasting, yielding material of the purest quality.

Windrowing enables the mined material to be deposited behind the machine in a continuous process.

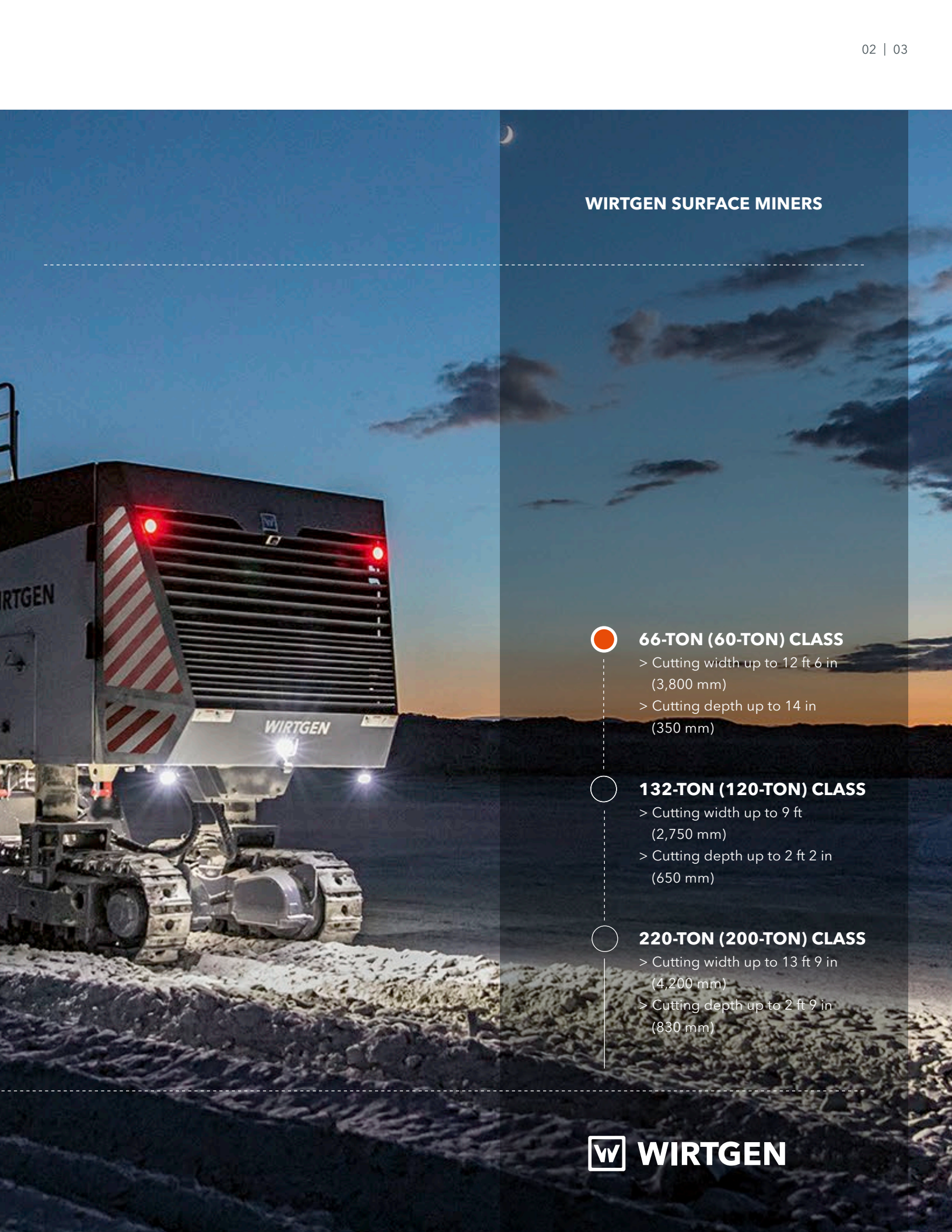

WIRTGEN SURFACE MINERS

66-TON (60-TON) CLASS

- > Cutting width up to 12 ft 6 in (3,800 mm)
- > Cutting depth up to 14 in (350 mm)

132-TON (120-TON) CLASS

- > Cutting width up to 9 ft (2,750 mm)
- > Cutting depth up to 2 ft 2 in (650 mm)

220-TON (200-TON) CLASS

- > Cutting width up to 13 ft 9 in (4,200 mm)
- > Cutting depth up to 2 ft 9 in (830 mm)

OVERVIEW OF HIGHLIGHTS

Perfectly Equipped

01 High-Production Cutting Drum Unit

- > Efficient cutting drum for high-quality windrowing applications
- > Cutting drum housing optimized to minimize wear during operation
- > Effective scraper blade deposits the cut material as an even surface
- > Six different cutting drum speeds minimize tool wear

02 High-Performance Engine Technology

- > High-powered Cummins diesel engine
- > Large diesel tank for extended uptimes
- > Controlled fan speed for low noise emission levels and reduced diesel consumption

03 Durable Components

- > Track units in heavy-duty design
- > Large-displacement engine
- > High-volume hydraulic pumps and numerous hydraulic fluid pressure filters

04 Reliable Operation

- > Pre-pressurized hydraulic tank
- > High filter capacity of water system for low cutting tool wear
- > Hydraulic side plate cylinders with integrated heavy-duty displacement sensors
- > Central lubrication system with three separate lubricating circuits

05 Effective Safety Concept

- > Sound-insulated, anti-vibration mounted ROPS / FOPS cabin
- > ROPS / FOPS-certified trainer's seat inside the cabin
- > Quick and easy replacement of cutting tools
- > Mechanical lockout of electrical system during machine stoppages / maintenance (battery and starter isolators)
- > Manual valves allow safe manoeuvring of the machine in emergency operation
- > Simple mechanical lock to prevent sudden inadvertent lowering of the machine during maintenance procedures



06 Ease of Operation and High Operator Comfort

- > High-precision **LEVEL PRO PLUS** leveling system
- > Ergonomically optimized cabin and operating concept
- > Automated lowering and raising of the cutting drum for the simple, accurate production of ramps in opencast mining
- > Automatic parallel machine height adjustment, front and rear
- > 5-V USB port and 12-V and 24-V sockets inside the cabin

07 Quick Manoeuvring

- > Hydraulic all-track steering system with Ackermann steering geometry to minimize wear during turning
- > Electronic optimization of tractive power to ensure maximum traction
- > Large ground clearance for quick manoeuvring on difficult ground
- > Reversing camera and reverse assist for smooth manoeuvring

08 Intelligent Maintenance Concept

- > Easy access to points of maintenance and servicing
- > Walk-in engine compartment
- > Plain text displays for quick troubleshooting
- > Easy cleaning of cooling system
- > Hydraulic tank can be easily removed for cleaning purposes

09 Efficient Machine Management

- > Standardized data interface for different customer systems



HIGH-PRODUCTION CUTTING DRUM UNIT

The cutting drum unit installed in the 220 SM(i) offers a cutting width of 7 ft 3 in (2.2 m) and is the core element of the top performer. It achieves high productivity levels in cutting primary resources with an unconfined compressive strength of 50 MPa selectively and depositing the material behind the machine as an even surface.

Efficient Cutting Drum

Designed specifically for high-quality windrowing applications, the cutting drum is highly efficient in translating the engine power into maximum cutting performance and in-

creased productivity. It is fitted with high, slender holder bases which optimize the flow of material and minimize energy consumption.

Optimized Cutting Drum Housing

Tailored to real-life requirements, the cutting drum unit optimizes the flow of material. This results in a significant reduction of wear and tear of the cutting drum housing, holders, point-attack tools and scraper blade.

01

High Productivity and Low Operating Costs

Extremely robustly designed cutting drum



- 01 The picks are arranged in a specific pattern tailored to the windrowing method.
- 02 Depositing the cut material as an even surface reduces wear and tear of the rear track units.

Effective Scraper Blade

Designed in accordance with field requirements, the scraper blade deposits the cut material behind the machine as an even surface.

Six Cutting Drum Speeds

Six different cutting drum speeds can be set to allow perfect adjustment to the material to be cut. This feature significantly reduces wear and tear of the cutting tools while increasing productivity at the same time.

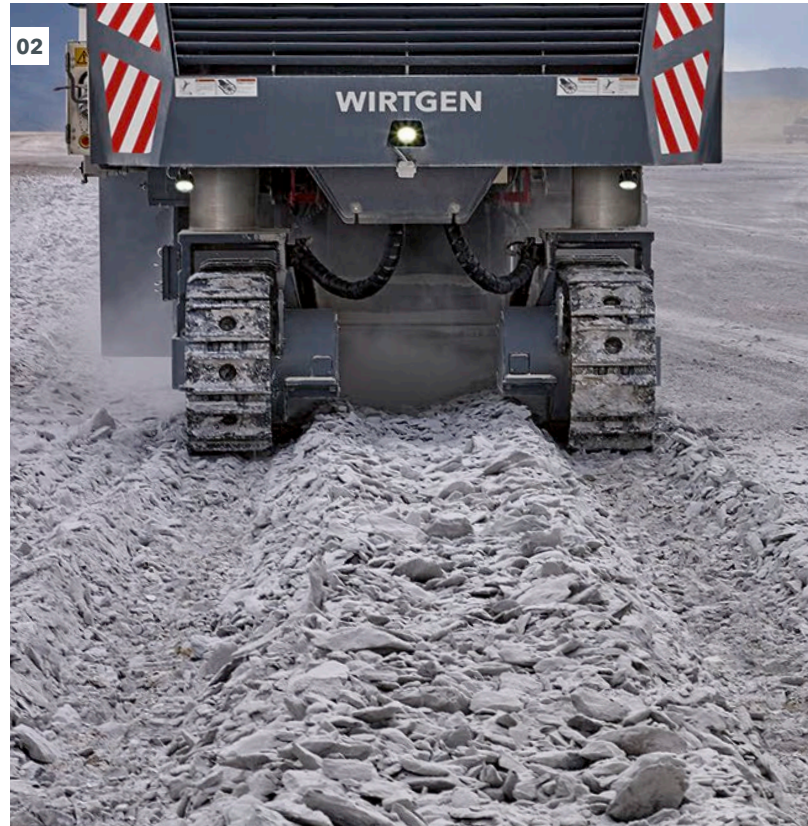

HIGH-PERFORMANCE ENGINE TECHNOLOGY

The surface miner's tremendous engine performance makes a significant contribution towards achieving high cutting performance and high daily production rates.

High-Powered Cummins Diesel Engine

The 220 SM(i) is equipped with a high-powered Cummins diesel engine. The engine impresses with fuel economy thanks to high-pressure injection and an intelligent engine management system. The engine technology used in the 220 SM complies with the emission standards of US Tier 2 (EU not regulated). The 220 SMi complies with the stringent specifications of exhaust emission standards EU Stage 5 / US Tier 4f.

Large Diesel Tank

The large diesel tank of the 220 SM(i) holds 607.6 gal (2,300 liters) of diesel to ensure extended uptimes without the need for refueling. As a result, fewer tanker trucks need to approach the miner.

Fan Speed Control

The cooling system and fan speed governed in accordance with requirements ensure reduced fuel consumption and lower noise emission levels.

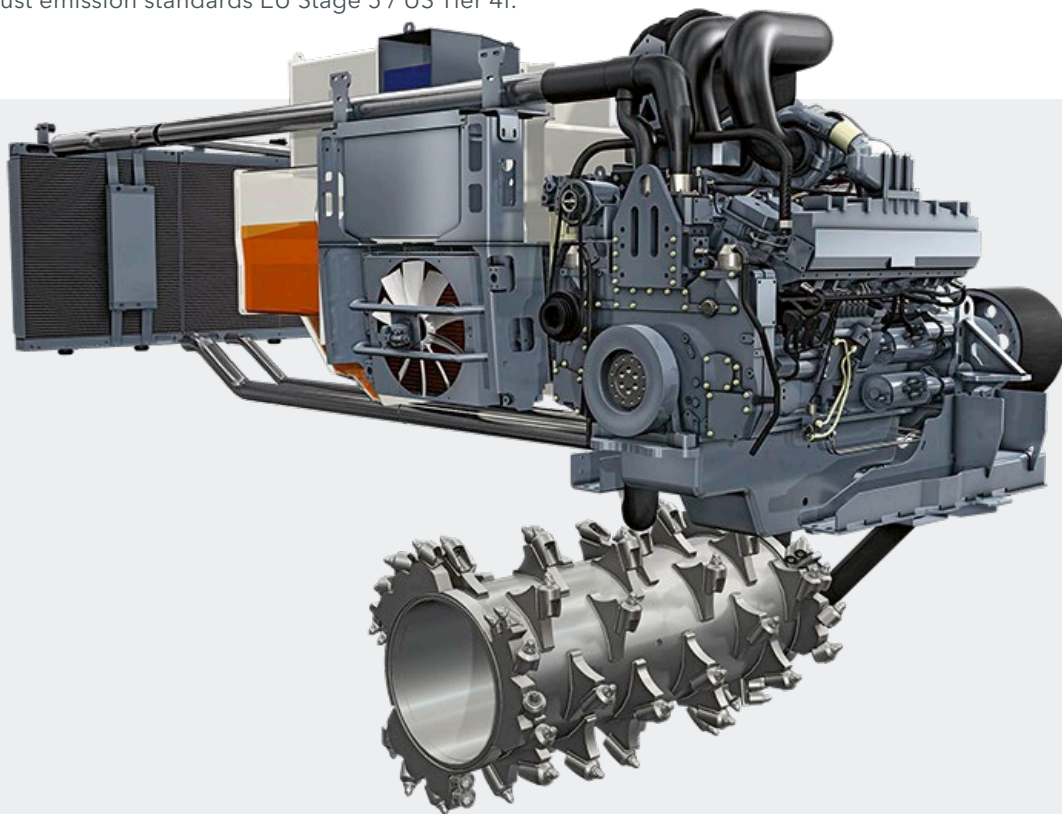

01 Thanks to its high-powered engine, the 220 SM(i) is an ideal candidate for tough opencast mining operations.

02 High efficiency is a hallmark of the miner's mechanical cutting drum drive via power belt in the strength-sapping extraction of primary resources using the windrowing method.

Rugged and Powerful

Long-life, economy-optimized mining engine

Fuel-efficient Cooling

Load-dependent cooling fan speed



DURABLE COMPONENTS

Built for the Toughest Jobs

Heavy duty components

High Machine Utilization Rates

Wear-resistant materials

01



- 01 Sturdy design extends the service life of the track units.
- 02 The cutting drum housing is manufactured from exceptionally wear-resistant materials.



All components of the 220 SM(i) have been designed for use in extremely tough opencast mining operations. The result: exceptional durability of the components and minimized downtimes of the miner for increased productivity and economic efficiency.

Track Units in Heavy-Duty Design

In opencast mining operations, the track units are exposed to extremely high levels of stress and strain. Heavy-duty track units fitted with sturdy double grouser track pads enable the 220 SM(i) to achieve high advance rates even in difficult mining situations. The generous design of all track components additionally increases the machine's availability at extended uptimes.

Large Displacement Engine

Large displacement ensures a long life of the diesel engine, which results in high availability and reliable performance of the entire machine.

High-Volume Hydraulic Pumps

Reliable machine operation on a permanent basis is ensured by the high-volume hydraulic pumps installed in the 220 SM(i). The large number of pressure filters additionally protects the hydraulic system against contamination by solid particles.

RELIABLE OPERATION

Nothing is more important in opencast mining than the reliable long-term availability of the machine. That is why we have designed the main components of the miner to ensure their extended service life even when exposed to extreme levels of stress and strain.

Pre-Pressurized Hydraulic Tank

The pre-pressurized hydraulic tank prevents dust and dirt from entering the hydraulic system. Filters installed in all hydraulic circuits keep the system clean to ensure reliable operation. Clean oil not only makes a significant contribution towards extending the service life of downstream components but also ensures optimum transmission of power.

High-Capacity Filters in the Water System

Well-cooled point-attack cutting tools offer improved resistance to wear and tear. Water of high quality and reliable cooling of the tools are therefore of vital importance. Clean water is, however, rarely found in opencast mining operations. Filter elements with an extra-large sieve surface have therefore been installed in the water system to ensure reliable operation of the system and minimize cutting tool wear and tear.

01



Hydraulic Side Plate Cylinders with Heavy-Duty Displacement Sensors

The ground is scanned by heavy-duty displacement sensors integrated into the hydraulic side plate cylinders. The measured results are used to produce bench floors and haulage roads of unrivaled evenness.

Central Lubrication System with Three Lubricating Circuits

The central lubrication system with three separate lubricating circuits can be relied on to supply all lubrication points of the 220 SM(i). Lubrication is monitored in an automated process, thus ensuring an extended uptime of the machine.

02



01 - 02 High machine availability ensures permanently high daily production rates in both soft and hard rock.



Maximum Continuous Mining Performance

Reliable operations

EFFECTIVE SAFETY CONCEPT

01



Compliant with Stringent Safety Regulations

Safety for operating and maintenance personnel

The safety of machine operators and maintenance staff is a top priority in opencast mining. The 220 SM(i) is designed to fully comply even with strict mining regulations.

ROPS / FOPS Cabin as Standard

The anti-vibration mounted, fully soundproofed cabin enables the operator to work at ease for many hours.

Trainer’s Seat Inside the Cabin

The additional seat inside the cabin is certified to ROPS / FOPS standards, permitting operators to be trained under real-life conditions.

Quick and Easy Replacement of Cutting Tools

The hydraulically opening scraper blade provides ready and safe access to the cutting drum from the rear. The cutting tools are replaced with the engine switched off. Ample room to move, hydraulic tool extractor and drum turning device are additional features which simplify the process.

Lockout of Electrical System

Accidental start-up of the machine can be prevented mechanically by locking the battery and starter isolators so that maintenance procedures can be safely performed while the machine is stationary.

Manual Valves for Emergency Operation

Manual valves enable the machine to be safely maneuvered to a parking area in emergency operation.

Lock Preventing Sudden Inadvertent Lowering of the Machine

The simple mechanical lock installed at the lifting columns for maintenance purposes safely prevents the machine from lowering suddenly and inadvertently in the event of pressure drops.



01 The operator is protected from external hazards in the ROPS / FOPS cabin.

02 Easy installation of the lock preventing sudden inadvertent lowering of the machine.

03 The battery-operated hydraulic drum turning device enables cutting tools to be replaced with the engine switched off.



COMFORT & CONVENIENCE - THE OPERATOR'S CABIN





EASE OF OPERATION PAIRED WITH OPERATOR COMFORT

01



Everything under Control
Intuitive, ergonomic operating concept

Always Makes the Grade
LEVEL PRO *PLUS*



01 The clearly structured, ergonomically designed cabin is paired with ease of operation to reduce stress and increase productivity.

02 Ergonomically designed controls integrated into the armrests contribute to intuitive operation.

Ease of operation, ergonomic design and operator comfort are key efficiency drivers. Taken together, they translate into greater productivity and profitability in every job.

LEVEL PRO PLUS Leveling System

The **LEVEL PRO PLUS** leveling system, which has proven its worth in both road construction and mining operations, offers easy, intuitive operation. Sensors installed at the side plates and an additional slope sensor can be used to produce a precisely defined horizontal or inclined surface. The machine is pre-fitted for GPS or laser-based control or for leveling by means of Multiplex ultrasonic sensors.

Ergonomically Optimized Operating Concept

The ergonomically designed controls have been integrated into the armrest of the driver's seat. All important machine features have been intelligently combined in the multifunctional joysticks. The driver's seat with spring and air cushioning can be fully adjusted to the operator's personal preferences. In addition, the spacious cabin offers heating and air-conditioning as well as ample room to move.

Automated Lowering and Raising of the Cutting Drum

This innovative complementary feature enables the 220 SM(i) to produce the ramps needed in opencast mining accurately in an automated process and within an extremely short period of time.

Parallel Height Adjustment

Parallel height adjustment of the miner at the front and rear can be performed conveniently at the mere push of a button.

5-V USB Port and 12-V and 24-V Sockets

Separate ancillary equipment can be connected via a 5-V USB port and 12-V and 24-V sockets installed in the operator's cabin.

QUICK MANEUVERING

Experience has shown that the terrain of opencast mining operations often holds unexpected difficulties. This is where maximum traction, manoeuvrability and high ground clearance are needed. The 220 SM(i) meets these challenges with ease.

Hydraulic All-Track Steering System

The miner's hydraulic all-track steering system with Ackermann steering geometry minimizes wear during turning maneuvers. In combination with the machine's compact dimensions, excellent maneuverability is ensured even in tight working conditions. As a result, the 220 SM(i) is repositioned quickly to keep interruptions of the productive cutting process as brief as possible.

01



Outstanding Maneuverability

Hydraulic all-track steering

Fast Maneuvering

Rear view camera

- 01** Small turning radii and large ground clearance are hallmarks of the 220 SM(i).
- 02** Quick maneuvering using the reversing camera improves the overall productivity of the machine.



Optimization of Tractive Power

Electronic optimization of the machine's tractive power guarantees maximum traction of all four track units to ensure high advance rates and cutting performance.

Large Ground Clearance

The separately height-adjustable track units offering large ground clearance and integrated stroke measurement systems enable effortless maneuvering of the machine even on uneven ground.

Reversing Camera

The reversing camera offers a good view towards the rear, thus allowing for the quick and safe maneuvering of the machine. The reverse assist system provides additional support to the machine operator.

INTELLIGENT MAINTENANCE CONCEPT

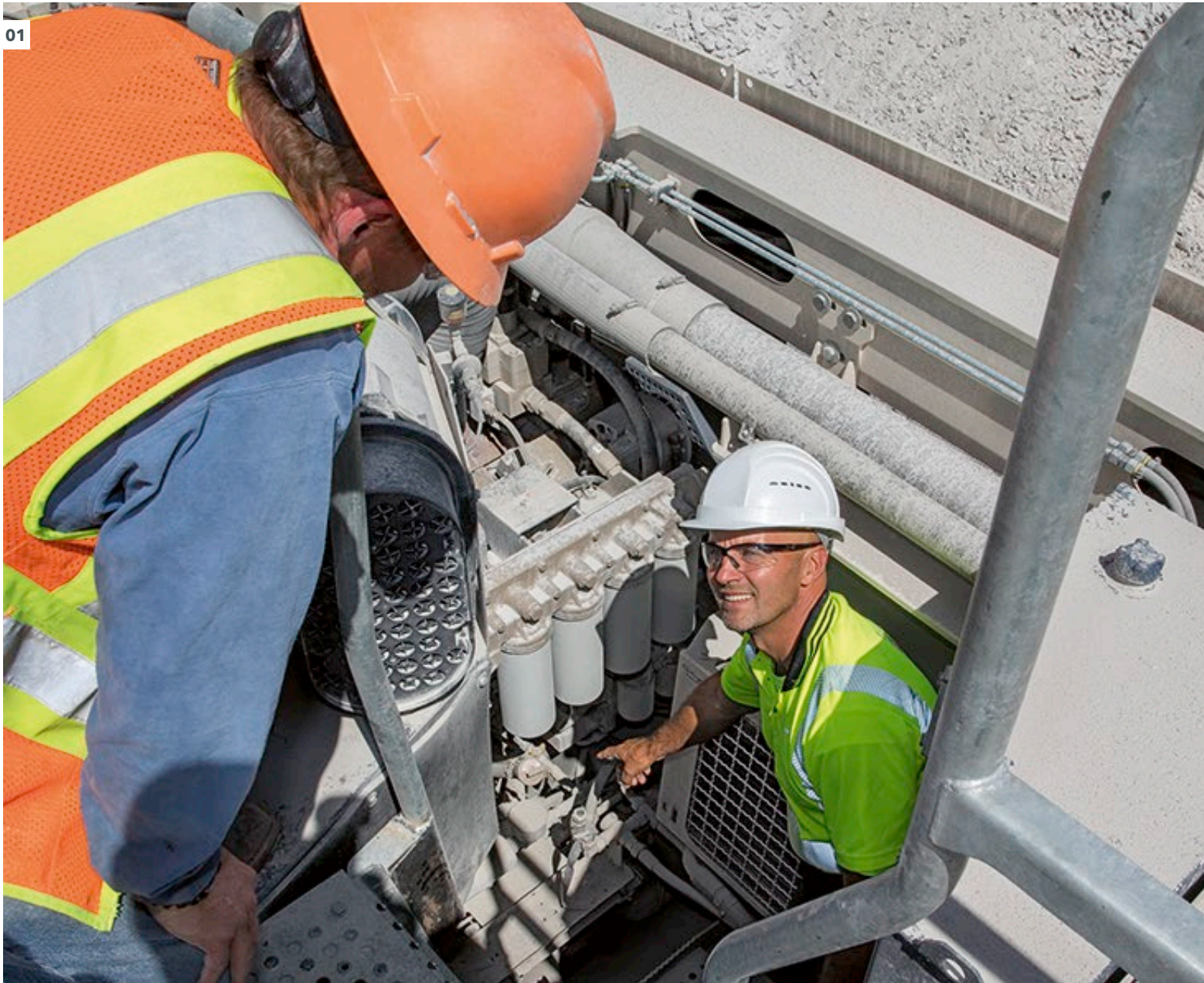

Easy Maintenance
Walk-in engine compartment

Fast and Simple
Good accessibility

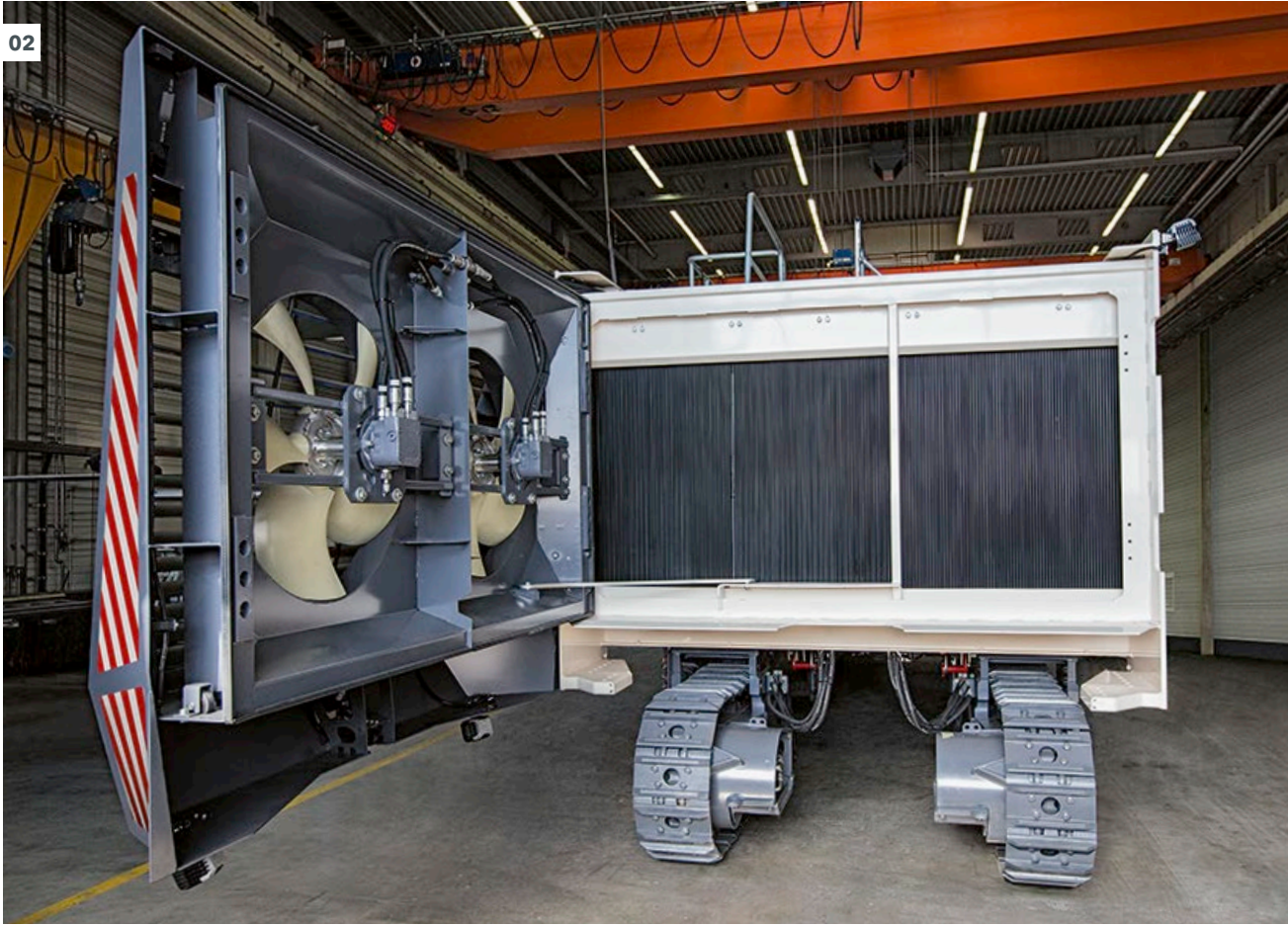

02

- 01 Quick access to the engine and cooling system.
- 02 The 220 SM(i) offers quick access for maintenance procedures - both in the workshop and in the field.

Operations in opencast mining require machine availability around the clock - minimizing maintenance requirements is therefore of vital importance. The intelligent maintenance concept of the 220 SM(i) increases production time, extends the life of machine components and optimizes machine availability.

Readily Accessible Points of Maintenance

All points of maintenance and servicing are readily accessible from the ground or from inside the machine. They enable maintenance procedures on the machine to be completed safely and quickly without the need for extended setup times.

Walk-in Engine Compartment

Reliable maintenance of the diesel engine is ensured by the walk-in engine compartment. Air, fuel and hydraulic fluid filters offer direct access.

Quick Troubleshooting

Central power supply and plain text displays on the control screen enable quick, effective troubleshooting to ensure high machine reliability in operation.

Easy Cleaning of Cooling System

The cooling system including fan is located at the rear of the machine and engine room. It offers quick access to ensure quick and easy cleaning.

Removable Hydraulic Tank

The hydraulic tank can be easily removed for cleaning purposes so that cleaning is completed within a short period of time.

EFFICIENT MACHINE MANAGEMENT

Telematics systems offer customers online access to operating parameters of the 220 SM(i) independent of the machine's current location.

Data Interface for Customer Systems

The standardized data interface enables easy integration of the 220 SM(i) into the customer's own telematics and dispatch sys-

tem. The scope of data supplied by the interface is variable and based on the WIRTGEN GROUP's FMS standard.

Numbers such as productive times and operating hours can be precisely documented via the data interface, thus providing a reliable record of machine times and machine parameters.

Assure 24/7 Productivity

State-of-the-art telematics









The 220 SM(i) is the prime choice not only for use in small and medium-scale mining operations but also for routing work and infrastructure projects. The compact, multipurpose surface miner extracts primary resources with an unconfined compressive strength of up to 50 MPa selectively and at a cutting depth of up to 14 in (350 mm). The 7 ft 3 in (2.2-m) wide cutting drum unit is tailored precisely to the specific application and guarantees high productivity at low operating costs.



TECHNICAL SPECIFICATIONS	220 SM	220 SMi
Cutting Drum		
Max. cutting width	7 ft 3 in (2,200 mm)	
Cutting depth ¹⁾	0 - 14 in (0 - 350 mm)	
Drum diameter with tools	4 ft 3 in (1,300 mm)	
Engine		
Manufacturer	Cummins	
Type	QST30	
Cooling	Water	
Number of cylinders	12	
Rated power at 2,100 rpm	708 kW / 950 HP / 963 PS	
Displacement	8.1 gal (30.5 l)	
Fuel consumption, full load	49.4 gal/h (187 l/h)	
Fuel consumption, ² / ₃ load	33.3 gal/h (126 l/h)	
Emission standards	No EU regulation / US Tier 2	EU Stage 5 / US Tier 4f
Electrical System		
Power supply	24 V	
Tank Capacities		
Fuel	607.6 gal (2,300 l)	
AdBlue® / DEF ²⁾	—	79.3 gal (300 l)
Hydraulic fluid	76.6 gal (290 l)	
Water	1,056.7 gal (4,000 l)	
Driving Properties		
Operating and travel speed	0 to 276 ft/min (0 to 3.1 mph) (0 to 84 m/min (0 to 5 km/h))	
Crawler Units		
Crawler units front and rear (L x W x H)	7 ft 9 in x 14.2 in x 33.2 in (2,375 x 360 x 843 mm)	
Shipping Dimensions		
Machine without cutting drum assembly (L x W x H)	32 ft 10 in x 9 ft 10 in x 9 ft 10 in (10,000 x 3,000 x 3,000 mm)	
Machine with cutting drum assembly (L x W x H)	32 ft 10 in x 9 ft 10 in x 11 ft 9 in (10,000 x 3,000 x 3,570 mm)	

TECHNICAL SPECIFICATIONS	220 SM	220 SMi
Weight of Base Machine		
Empty weight of machine without fluids	110,471 lbs (50,100 kg)	112,345 lbs (50,950 kg)
Operating weight, CE ³⁾	117,196 lbs (53,150 kg)	119,070 lbs (54,000 kg)
Operating weight, max. (full tanks)	132,851 lbs (60,250 kg)	134,726 lbs (61,100 kg)
Transport Weights of Individual Components		
Cutting drum assembly	24,586 lbs (11,150 kg)	
Weights of Operating Agents		
Water	8,820 lbs (4,000 kg)	
Diesel (6.9 lbs/gal (0.83 kg/l))	4,190 lbs (1,900 kg)	
AdBlue® / DEF ²⁾ (9.2 lbs/gal (1.1 kg/l))	-	728 lbs (330 kg)

¹⁾ The maximum cutting depth may deviate from the value indicated, due to tolerances and wear.

²⁾ AdBlue® is a registered trademark of the German Association of the Automotive Industry (VDA).

³⁾ Weight of machine with half-full water tank, half-full fuel tank, driver (165.4 lbs (75 kg)) and on-board tools, excluding optional equipment.

SIDE VIEW 220 SM(i)

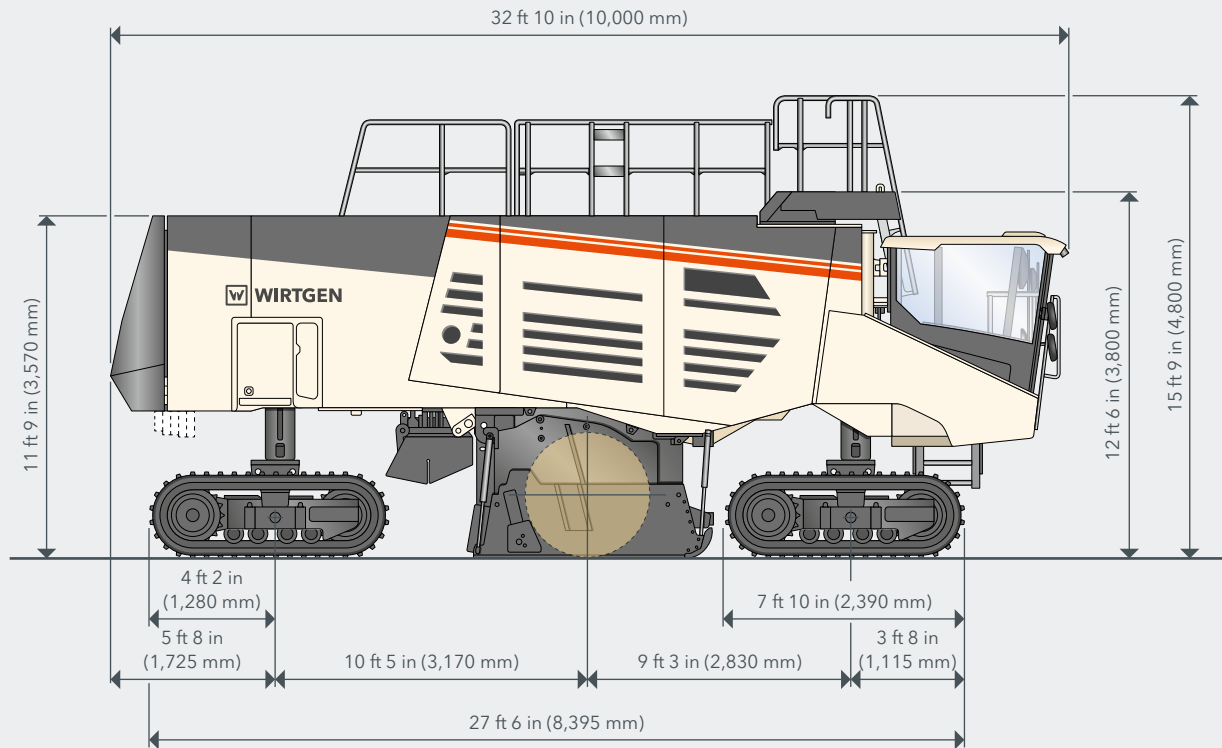

TOP VIEW 220 SM (i)

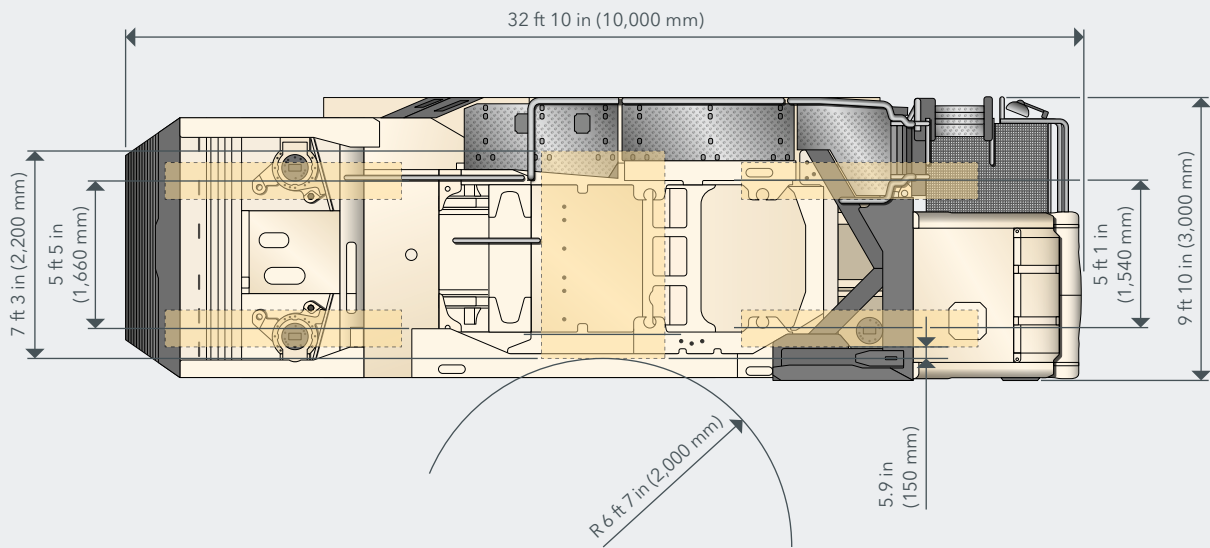

STANDARD EQUIPMENT	220 SM	220 SM i
Basic Machine		
> Base machine with engine	■	■
> Engine-air-intake with highly efficient pre-separator	■	■
> Reduced diesel consumption and low noise emissions as a result of temperature-controlled fan speed	■	■
> Separate battery master switch for disconnecting the starter	■	■
> Automatic central lubrication system	■	■
Cutting Drum Unit		
> Robust and efficient mechanical milling drum drive via power belts (total of 18 grooves) with automatic belt tensioner	■	■
> Variable cutting speed by a combination of 3 selectable engine speeds and adjustable drive belt pulley arrangements to achieve optimum working results	■	■
> Water spray bar on the cutting drum unit	■	■
> Cutting drum housing FB2200 (7 ft 3 in)	□	□
Cutting Drums		
> Cutting drum FB2200 (7 ft 3 in) HT6 LA50 with 68 picks	□	□
Machine Control and Leveling System		
> Advance control across the entire speed range via an ergonomic joystick with proportional control characteristics	■	■
> Traction control system reduces wear on crawler components at maximum traction	■	■
> Automatic advance rate control to assist the operator in keeping the engine's ideal operating point	■	■
> Cutting depth regulation with an integrated leveling system using the side plates and the LEVEL PRO PLUS leveling system. The leveling system is fully integrated in the machine display.	■	■
> The standard transverse slope control maintains the machine's transverse tilt regardless of the terrain. This means exact surface levels, either horizontal or slanted, can be created.	■	■
Operator's Cabin		
> Comfortable, high-quality, fully glazed, elastically mounted cabin with roof hatch	■	■
> Equipped with an air-cushioned seat and all the necessary control instruments integrated into the armrests	■	■
> Includes 12 V and 24 V sockets and a 5 V USB port	■	■
> Multifunctional color control display that shows important machine operating conditions	■	■
> Comprehensive machine diagnostics displayed on the control screen	■	■
> Powerful air conditioner for cooling and heating	■	■
> Provides machine operator with roll-over protection system (ROPS) and falling-object protection system (FOPS)	■	■

STANDARD EQUIPMENT	220 SM	220 SM i
Chassis and Height Adjustment		
> Track units with exceptionally sturdy double-grouser track pads in heavy-duty design for mining applications	■	■
> Infinitely variable, hydraulic four-track drive	■	■
> Four-track steering system offering the following steering modes: crab, cornering or straight-ahead mode	■	■
Miscellaneous		
> Reversing camera with graphical reversing assistant	■	■
> "Welcome-and-Go-Home-Light" with LED lighting in the ladder area	■	■
> High-pressure water cleaner (580 psi (40 bar) and a large quantity of water) with washing lance for cleaning the machine	■	■
> LED working lights, 24 V, with magnetic base	■	■
> Rotary beacon LED 24 V	■	■
> Set of tools for maintenance and servicing	■	■
> Extensive safety package including easily accessible emergency stop switches, an integrated machine safety feature, protecting it from unintended transverse tilts, large non-slip walkways, a lockable main switch and starting switch and position lights	■	■
> European type certification, EuroTest mark and CE conformity	■	■
> Consumables for use in moderate and warm weather conditions (up to -15°C / 5°F)	□	□
> Water filling from above using an external pump. (The filling pump is not included in the delivery).	□	□
> Standard painting in RAL 9001 (cream)	□	□
> WITOS - professional telematics solution for machine operation and service optimization	□	□
> Standard LED lighting system with 19,800 lumens	□	□

- = Standard equipment
- (grey) = Standard equipment, can be replaced with optional equipment if desired
- (white) = Optional equipment

OPTIONAL EQUIPMENT	220 SM	220 SM i
Cutting Drums		
> Cutting drum FB2200 (7 ft 3 in) HT14 LA75 with 44 picks	<input type="checkbox"/>	<input type="checkbox"/>
> Cutting drum FB2200 (7 ft 3 in) HT14 LA50 with 56 picks	<input type="checkbox"/>	<input type="checkbox"/>
Machine Control and Leveling System		
> Level control 3D leveling pre-equipment	<input type="checkbox"/>	<input type="checkbox"/>
> Additional operating display LEVEL PRO PLUS	<input type="checkbox"/>	<input type="checkbox"/>
Miscellaneous		
> Consumables for use in cold weather conditions (from -15°C / 5°F)	<input type="checkbox"/>	<input type="checkbox"/>
> Hydraulically operated filling pump for water refilling	<input type="checkbox"/>	<input type="checkbox"/>
> Painting in one special color (RAL)	<input type="checkbox"/>	<input type="checkbox"/>
> Model without WITOS	<input type="checkbox"/>	<input type="checkbox"/>
> Powerful LED lighting system	<input type="checkbox"/>	<input type="checkbox"/>
> Additional weight 9,920 lbs (4,500 kg) on the rear of the machine	<input type="checkbox"/>	<input type="checkbox"/>
> Radio system with two speakers and antenna	<input type="checkbox"/>	<input type="checkbox"/>
> Auxiliary heating for cabin	<input type="checkbox"/>	<input type="checkbox"/>
> Additional monitor brackets	<input type="checkbox"/>	<input type="checkbox"/>
> Mobile coolbox 24 V	<input type="checkbox"/>	<input type="checkbox"/>
> Cold-start aid, 400 V, without generator	<input type="checkbox"/>	<input type="checkbox"/>
> Cutting drum rotation device, electro-hydraulic	<input type="checkbox"/>	<input type="checkbox"/>
> Hydraulic pick ejector for HT14 toolholder system	<input type="checkbox"/>	<input type="checkbox"/>
> Wiggins fast-fill system for diesel refueling	<input type="checkbox"/>	<input type="checkbox"/>
> Wiggins fast-fill system for AdBlue® refilling	<input type="checkbox"/>	<input type="checkbox"/>
> Camera system with four cameras and additional monitor	—	<input type="checkbox"/>

OPTIONAL EQUIPMENT	220 SM	220 SM i
Miscellaneous		
> Heavy-duty rollers to help with the assembly of the drum housing	<input type="checkbox"/>	<input type="checkbox"/>
> LED working light 24 V with magnetic base	<input type="checkbox"/>	<input type="checkbox"/>
> Oil, filter and maintenance kit for first Service after 50 working hours	<input type="checkbox"/>	<input type="checkbox"/>
> Workshop container 20' including workshop equipment	<input type="checkbox"/>	<input type="checkbox"/>
> Workshop equipment - tools	<input type="checkbox"/>	<input type="checkbox"/>
> Workshop equipment - auxiliary equipment and consumables	<input type="checkbox"/>	<input type="checkbox"/>
> Workshop equipment - metric fastening elements	<input type="checkbox"/>	<input type="checkbox"/>
> Workshop equipment - electrical repairs	<input type="checkbox"/>	<input type="checkbox"/>
> Workshop equipment - hydraulic components	<input type="checkbox"/>	<input type="checkbox"/>
> Workshop equipment - hydraulic press	<input type="checkbox"/>	<input type="checkbox"/>
> Workshop equipment - hoses for emergency repairs	<input type="checkbox"/>	<input type="checkbox"/>

- = Standard equipment
- = Standard equipment, can be replaced with optional equipment if desired
- = Optional equipment





**WIRTGEN AMERICA Inc.**

6030 Dana Way
Antioch, TN 37013
USA

P: (615) 501-0600

F: (615) 501-0691

 www.wirtgen-group.com/america



For further information, please scan the code.